

Rinaldi Tools[®] GmbH

DER Fachshop-Spezialist für

Zerspanungsbetriebe



WERKZEUG ÜBERSICHT 2024



Generalimporteur für Deutschland



Gültig ab dem 01.01.2024

Grußwort

Sehr geehrte Kunde,

ein weiteres Jahr ist vergangen, und es war für die Firma Rinaldi-Tools äußerst ereignisreich. Wir haben unser Team weiter verstärkt, neue, größere Räumlichkeiten bezogen und ein Nachhaltigkeitsprogramm ins Leben gerufen. Seit Juni sind wir stolz darauf, eine europaweit registrierte Marke zu sein.

Unser Lieferprogramm erweitert sich kontinuierlich, und in dieser Broschüre präsentieren wir Ihnen auch im Jahr 2024 unseren "Best of" Übersichtskatalog. Beim Durchblättern werden Sie feststellen, dass wir bewusst entschieden haben, unsere Preise nicht zu erhöhen oder nur minimale Anpassungen vorzunehmen, wo es leider unvermeidlich war. Mit dieser Entscheidung setzen wir ein deutliches Zeichen gegen den aktuellen Trend in der Branche.

Wir zeigen, dass es auch anders geht.

Bitte beachten Sie, dass das Programm in dieser Broschüre bei Weitem nicht unser gesamtes Lieferprogramm abbildet. Sollten Sie also Werkzeuge benötigen, die Sie nicht in unserer Broschüre oder in unserem Online-Shop finden, zögern Sie nicht, uns anzurufen. Unsere kompetenten Mitarbeiter helfen Ihnen gerne, das richtige Werkzeug für Ihre Anwendung zu finden.

Wir danken Ihnen für Ihr Vertrauen in Rinaldi-Tools und freuen uns darauf, auch in Zukunft Ihr zuverlässiger Partner in Sachen hochwertiger Werkzeuge zu sein.

Herzlichst,



Michael Rinaldi
Firmengründer
Geschäftsführer



Marco Rinaldi
Geschäftsführer

Warum sollten wir auch Ihr Werkzeuglieferant sein?

- Erfahrung in der Hartmetall-Branche seit 1988.
- Große Produktauswahl.
- 24 Stunden Bestellmöglichkeit im Onlineshop.
- Einzigartiges Preis-Leistungs-Verhältnis
- Versand mit UPS.

NEUES IM JAHR 2024

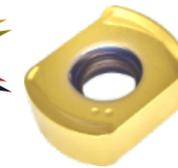

HOCHVORSCHUB-FRÄSSYSTEM LNMX 0904 DURCHMESSER 25 BIS 100 MM

Seite 41

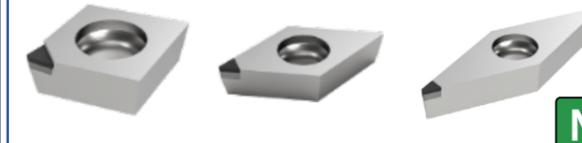

PKD WENDESCHNEIDPLATTEN HIGH SPEED ALUDREHEN

Seite 25



INNENSTECHHALTER BEKTR/L FÜR MGMM/MRMN MIT INNENKÜHLKANÄLEN

Seite 29



EINSTELLBARE SCHRUPP-SCHLICHT-SPINDELKÖPFE SBT-CC 0602../09T3/1204

Seite 68



HOCHVORSCHUB 3-SCHNEIDEN VBH-BOHRER

Seite 71

INDEX

DREHEN

Negative Drehplatten u. Halter	S. 04
Positive Drehplatten u. Halter	S. 12
Hartmetall-Innendrehhalter	S. 23
CBN-Wendeschneidplatten	S. 24
PKD-Wendeschneidplatten	S. 25
Ein- und Abstechen	ab S. 26
ZA-Steckschwert-System	S. 26
GTN-Steckschwert-System	S. 27
MGMM/MRMN Stechsystem	S. 28
RT16 Stechsystem	S. 31
Gewindebearbeitung	S. 32
Microzerspanung	S. 36
Multi-Cut	S. 37

FRÄSEN

Planfräser 45°	ab S. 38
SEET Planfräser	S. 38
SNEG Planfräser	S. 39
Hochvorschubfräser	ab S. 40
LNMX 03 Hochvorschubfräser	S. 40
LNMX 09 Hochvorschubfräser	S. 41
Eckfräser 90°	ab S. 42
ANGX Eckfräser 90°	S. 42
XNEX Eckfräser 90°	S. 43
VCGT Eckfräser 90°	S. 43
APKT 11 Eckfräser 90°	S. 44
Formfräser	S. 46
Fasenfräser	S. 48
T-Nutenfräser	S. 49
Scheibenfräser	S. 49
VHM-Fräser	ab S. 50
VHM-HPC-Fräser	S. 50
VHM-Schafffräser	S. 51
VHM-Untermassfräser	S. 52
VHM-Torusfräser	S. 52

VHM-Kugelfräser	S. 53
VHM-Fasenfräser	S. 54
VHM-Viertelkreisfräser	S. 54
VHM-Alu-Schafffräser	S. 55
VHM-ALU-Schrupfräser	S. 56
VHM-Alu-Kugelfräser	S. 57
VHM-Alu-Schafffräser (DLC)	S. 58
VHM-Hartfräser	S. 60
VHM-Hart-Kugelfräser	S. 61
VHM-Titanfräser	S. 62
VHM-Schafffräser Schruppb.	S. 64
VHM Gewindefräser	S. 64
HSS Fräser	S. 65

BOHREN

Wendeplattenbohrer SPMG	S. 66
Wendeplattenbohrer WCMX	S. 67
Einstellbare Schrupp-Schlicht-Spindelköpfe	S. 68
VHM-Bohrer	ab S. 69
VBU-Bohrer Universal	S. 69
VBS-Bohrer für Edelstahl & Sonderwerkstoffe	S. 70
VBH 3-Schneiden-High-Feed-Bohrer	S. 71
VHM-NC Anbohrer	S. 71
VBA-Bohrer für NE-Metalle	S. 72
VHM-Flachbohrer	S. 74
HSS-Gewindebohrer	ab S. 75
HSS-E, metrisch	S. 75
HSS-E, metrisch, Feingewinde	S. 76
HSS-PM, metrisch	S. 77
HSS-E, NE-Metalle	S. 78
HSS-E, zöllig	S. 79
Einsatzempfehlungen VHM-Bohrer	S. 80

MESSMITTEL

S. 80

ZUBEHÖR

S. 81

A-Z

ANGX Eckfräser 90°	S. 42	VHM 3-Schneiden-Bohrer	S. 71
APKT 11 Eckfräser 90°	S. 44	VHM-Alu-Kugelfräser	S. 57
CBN-Wendeschneidplatten	S. 24	VHM-Alu-Schafffräser	S. 55
Eckfräser 90°	ab S. 42	VHM-Alu-Schafffräser (DLC)	S. 58
Ein- und Abstechen	ab S. 26	VHM-Alu-Schrupfräser	S. 56
Einsatzempfehlungen VHM-Bohrer	S. 80	VHM-Bohrer	ab S. 69
Fasenfräser	S. 48	VHM-Bohrer Edelstahl	S. 70
Formfräser	S. 46	VHM-Bohrer NE-Metalle	S. 72
Gewindebearbeitung	S. 32	VHM-Bohrer Sonderwerkstoffe	S. 70
GTN-Steckschwert-System	S. 27	VHM-Bohrer Universal	S. 69
Hartmetall-Innendrehhalter	S. 23	VHM-Fasenfräser	S. 54
Hochvorschubfräser	ab S. 40	VHM-Flachbohrer	S. 74
HSS-E, metrisch	S. 75	VHM-Fräser	ab S. 50
HSS-E, metrisch, Feingewinde	S. 76	VHM Gewindefräser	S. 64
HSS-E, NE-Metalle	S. 78	VHM-Hartfräser	S. 60
HSS-E, zöllig	S. 79	VHM-Hart-Kugelfräser	S. 61
HSS Fräser	S. 65	VHM High-Feed-Bohrer	S. 71
HSS-Gewindebohrer	ab S. 75	VHM-HPC-Fräser	S. 50
HSS-PM, metrisch	S. 77	VHM-Kugelfräser	S. 53
LNMX 03 Hochvorschubfräser	S. 40	VHM-NC Anbohrer	S. 71
LNMX 09 Hochvorschubfräser	S. 41	VHM-Schafffräser	S. 51
Messmittel	S. 80	VHM-Schafffräser Schruppb.	S. 64
MGMM/MRMN Stechsystem	S. 28	VHM-Titanfräser	S. 62
Microzerspanung	S. 36	VHM-Torusfräser	S. 52
Multi-Cut	S. 37	VHM-Untermassfräser	S. 52
Negative Drehplatten u. Halter	S. 04	VHM-Viertelkreisfräser	S. 54
PKD-Wendeschneidplatten	S. 25	Wendeplattenbohrer SPMG	S. 66
Planfräser 45°	ab S. 38	Wendeplattenbohrer WCMX	S. 67
SEET Planfräser	S. 38	XNEX Eckfräser 90°	S. 43
SNEG Planfräser	S. 39	ZA-Steckschwert-System	S. 26
Hochvorschubfräser	ab S. 40	Zubehör	S. 81
LNMX 03 Hochvorschubfräser	S. 40		
LNMX 09 Hochvorschubfräser	S. 41		
Eckfräser 90°	ab S. 42		
ANGX Eckfräser 90°	S. 42		
XNEX Eckfräser 90°	S. 43		
VCGT Eckfräser 90°	S. 43		
APKT 11 Eckfräser 90°	S. 44		
Formfräser	S. 46		
Fasenfräser	S. 48		
T-Nutenfräser	S. 49		
Scheibenfräser	S. 49		
VHM-Fräser	ab S. 50		
VHM-HPC-Fräser	S. 50		
VHM-Schafffräser	S. 51		
VHM-Untermassfräser	S. 52		
VHM-Torusfräser	S. 52		
HSS-Gewindebohrer	ab S. 75		
HSS-E, metrisch	S. 75		
HSS-E, metrisch, Feingewinde	S. 76		
HSS-PM, metrisch	S. 77		
HSS-E, NE-Metalle	S. 78		
HSS-E, zöllig	S. 79		
Einsatzempfehlungen VHM-Bohrer	S. 80		
SEET Planfräser	S. 39		
SNEG Planfräser	S. 39		
Spindelköpfe	S. 68		
T-Nutenfräser	S. 49		
VCGT Eckfräser 90°	S. 43		

CN..

NEGATIVE WENDESCHNEIDPLATTE

ABMESSUNGEN

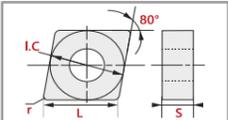
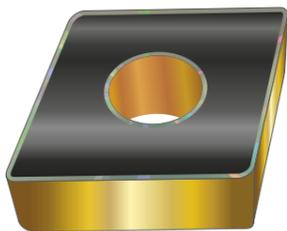

Art. Nr.	r	L	l.c	s
CN.. 120404	0,4	12,9	12,7	4,76
CN.. 120408	0,8	12,9	12,7	4,76
CN.. 120412	1,2	12,9	12,7	4,76
CN.. 120416	1,6	12,9	12,7	4,76
CN.. 160608	0,8	16,1	15,875	6,35
CN.. 160612	1,2	16,1	15,875	6,35
CN.. 160616	1,6	16,1	15,875	6,35
CN.. 160624	1,6	16,1	15,875	6,35
CN.. 190608	0,8	19,3	19,05	6,35
CN.. 190612	1,2	19,3	19,05	6,35
CN.. 190616	1,6	19,3	19,05	6,35
CN.. 190624	1,6	19,3	19,05	6,35

P CNMG FÜR DIE STAHLBEARBEITUNG

Art. Nr.	Schlichtbearbeitung	Preis
1661240	CNMG 120404-FP RT150+	3,90 €
1661241	CNMG 120408-FP RT150+	3,90 €
1661245	CNMG 120408-FP RT250+	3,90 €

Art. Nr.	Mittlere Bearbeitung	Preis
1661215	CNMG 120404-PM RT250+	3,90 €
1661220	CNMG 120408-PM RT250+	3,90 €
1661225	CNMG 120412-PM RT250+	3,90 €
1661250	CNMG 160608-PM RT225+	7,20 €
1661255	CNMG 160612-PM RT225+	7,20 €
1661260	CNMG 160616-PM RT225+	7,20 €
1661265	CNMG 190608-PM RT225+	8,70 €
1661270	CNMG 190612-PM RT225+	8,70 €
1661275	CNMG 190616-PM RT225+	8,70 €

Art. Nr.	Schruppbearbeitung	Preis
1661092	CNMM 120408-XR RT225+	4,40 €
1661088	CNMM 120412-XR RT225+	4,40 €
1661089	CNMM 120416-XR RT225+	4,40 €
1661093	CNMM 160608-XR RT225+	7,20 €
1661094	CNMM 160612-XR RT225+	7,20 €
1661095	CNMM 160616-XR RT225+	7,20 €
1661096	CNMM 160624-XR RT225+	7,20 €
1661097	CNMM 190612-XR RT225+	8,70 €
1661098	CNMM 190616-XR RT225+	8,70 €
1661099	CNMM 190624-XR RT225+	8,70 €

Art. Nr.	Schruppbearbeitung	Preis
1661230	CNMG 120408-PR RT225+	4,40 €
1661235	CNMG 120412-PR RT225+	4,40 €
1661236	CNMG 120416-PR RT225+	4,40 €
1661237	CNMG 160608-PR RT225+	7,20 €
1661238	CNMG 160612-PR RT225+	7,20 €
1661239	CNMG 160616-PR RT225+	7,20 €
1661231	CNMG 160624-PR RT225+	7,20 €
1661232	CNMG 190612-PR RT225+	8,70 €
1661233	CNMG 190616-PR RT225+	8,70 €
1661234	CNMG 190624-PR RT225+	8,70 €

H CNGA - CBN FÜR GEHÄRTETEN STAHL

Art. Nr.	CBN 2 Schneiden	Preis
1661591	CNMG 120404-2N RTC20T	29,50 €
1661592	CNMG 120408-2N RTC20T	29,50 €

M CNMG FÜR DIE EDELSTAHLBEARBEITUNG

Art. Nr.	Schlichtbearbeitung	Preis
1661071	CNMG 120404-FE RT305	3,90 €
1661076	CNMG 120408-FE RT305	3,90 €

Art. Nr.	Mittlere Bearbeitung	Preis
1661079	CNMG 120404-MM RT250M	3,90 €
1661077	CNMG 120408-MM RT250M	3,90 €
1661078	CNMG 120412-MM RT250M	3,90 €

Art. Nr.	Schruppbearbeitung	Preis
1661531	CNMG 120408-MR RT255M	4,60 €
1661532	CNMG 120412-MR RT255M	4,60 €

S CNMG FÜR SONDERWERKSTOFFE

Art. Nr.	Schlichtbearbeitung	Preis
1661541	CNGG 120404-SF RT110S	5,80 €
1661542	CNGG 120408-SF RT110S	5,80 €

Art. Nr.	Mittlere Bearbeitung	Preis
1661543	CNMG 120408-SM RT110S	4,90 €
1661544	CNMG 120412-SM RT110S	4,90 €

Art. Nr.	Schruppbearbeitung	Preis
1661545	CNMG 120408-SR RT110S	4,90 €
1661546	CNMG 120412-SR RT110S	4,90 €

K CNMG FÜR GUSS

Art. Nr.	Mittlere Bearbeitung	Preis
1661421	CNMG 120404-KC RT150K	4,40 €
1661422	CNMG 120408-KC RT150K	4,40 €
1661423	CNMG 120412-KC RT150K	4,40 €

N CNMG FÜR NE-METALLE

Art. Nr.	Preis
1661021	CNMG 120404-ALP RT100 4,20 €
1661022	CNMG 120408-ALP RT100 4,20 €



Abbildung zeigt R

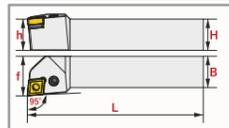

PCLNR/L (95°) FÜR CN.. - LÄNGSDREHEN/PLANDREHEN

Art. Nr. R	Art. Nr. L	h=H	B	L	f	Platte	Preis	
SM01619	SM01626	PCLNR/L 2020 K12	20	20	125	25	CN12	37,00 €
SM01640	SM01657	PCLNR/L 2525 M12	25	25	150	32	CN12	39,00 €
1111045	1111046	PCLNR/L 3225 P12	32	25	170	32	CN12	44,00 €
SM01701	SM01718	PCLNR/L 2525 M16	25	25	150	32	CN16	46,00 €
SM01732	SM01749	PCLNR/L 3232 P16	32	32	170	38	CN16	64,00 €
SM01763	SM01770	PCLNR/L 3232 P19	32	32	170	38	CN19	73,00 €

Zubehör	KNIEHEBEL	KNIEHEBELSCHRAUBE	UNTERLEGPLATTE	ROHRSTIFT
CN12	SPL1 - 9120	SLV1-M8x20 9224 (SW3)	BAX CN12-9603	SLAY1 - 9701
CN16	SPL2 - 9121	SLV2-M8x24 9225 (SW3)	BAX CN16-9604	SLAY2 - 9702
CN19	SPL3 - 9122	SLV3-M10x29 9226 (SW4)	BAX CN19-9605	SLAY3 - 9703



Abbildung zeigt R

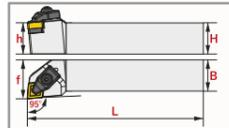

TCLNR/L (95°) FÜR CN.. - LÄNGSDREHEN/PLANDREHEN

Art. Nr. R	Art. Nr. L	h=H	B	L	f	Platte	Preis	
SM00025	SM00032	TCLNR/L 2020 K12	20	20	125	26	CN12	45,00 €
SM00056	SM00063	TCLNR/L 2525 M12	25	25	150	32	CN12	47,00 €

Zubehör	PRATZE	PRATZENSCHRAUBE	UNTERLEGPLATTE	UP-SCHRAUBE	FEDERSCHNEIBE
	TSK1 - 9101	TSBV M6x30 - 9205 (SW3)	BAX CN12-9603	TSAV M4x10 - 9403 (SW3)	TSP 6,5x12 - 9705



Abbildung zeigt R

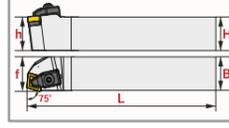

TCBNR/L (75°) FÜR CN.. - LÄNGSDREHEN MIT DER NEBENSCHNEIDE

Art. Nr. R	Art. Nr. L	h=H	B	L	f	Platte	Preis	
SM34082	SM34099	TCBNR/L 2525 M12	25	25	150	22,5	CN12	47,00 €

Zubehör	PRATZE	PRATZENSCHRAUBE	UNTERLEGPLATTE	UP-SCHRAUBE	FEDERSCHNEIBE
	TSK1 - 9101	TSBV M6x30 - 9205 (SW3)	BAX CN12-9603	TSAV M4x10 - 9403 (SW3)	TSP 6,5x12 - 9705



Abbildung zeigt R

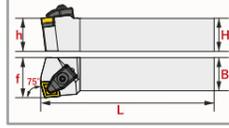

TCKNR/L (75°) FÜR CN.. - PLANDREHEN MIT DER NEBENSCHNEIDE

Art. Nr. R	Art. Nr. L	h=H	B	L	f	Platte	Preis	
SM44609	SM44616	TCKNR/L 2020 K12	20	20	125	26	CN12	45,00 €
SM44623	SM44630	TCKNR/L 2525 M12	25	25	150	32	CN12	47,00 €

Zubehör	PRATZE	PRATZENSCHRAUBE	UNTERLEGPLATTE	UP-SCHRAUBE	FEDERSCHNEIBE
	TSK1 - 9101	TSBV M6x30 - 9205 (SW3)	BAX CN12-9603	TSAV M4x10 - 9403 (SW3)	TSP 6,5x12 - 9705



Abbildung zeigt R

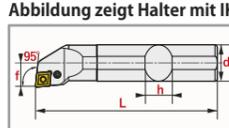

PCLNR/L (95°) FÜR CN.. - INNENAUSDREHEN/PLANDREHEN

Art. Nr. R	Art. Nr. L	d	h	L	f	Dmin	Platte	Preis	
SM05938	SM05945	S25S PCLNR/L 12	25	23	250	17	≥32	CN12	57,50 €
SM05952	SM05969	S32T PCLNR/L 12	32	30	300	22	≥40	CN12	76,00 €
SM05976	SM05983	S40U PCLNR/L 12	40	37,5	350	27	≥50	CN12	96,00 €
SM06010	SM06027	S40U PCLNR/L 16	40	37	350	27	≥50	CN16	107,20 €
SM40403	SM40410	A25R PCLNR/L 12 *	25	23	200	17	≥32	CN12	66,00 €
SM40304	SM40311	A32S PCLNR/L 12 *	32	30	250	22	≥40	CN12	89,00 €

* = mit Kühlkanal

Zubehör	KNIEHEBEL	KNIEHEBELSCHRAUBE	UNTERLEGPLATTE	ROHRSTIFT
12ER	SPL1 - 9120	SLV1-M8x20 9224 (SW3)	BAX CN12-9603	SLAY1 - 9701
16ER	SPL2 - 9121	SLV2-M8x24 9225 (SW3)	BAX CN16-9604	SLAY2 - 9702



Abbildung zeigt R

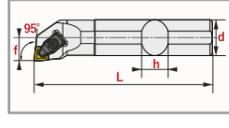

TCLNR/L (95°) FÜR CN.. - INNENAUSDREHEN/PLANDREHEN

Art. Nr. R	Art. Nr. L	d	h	L	f	Dmin	Platte	Preis	
SM38721	SM38714	S20R TCLNR/L-12	20	18	170	15	≥26	CN12	52,00 €
SM04764	SM04740	S25S TCLNR/L-12	25	23	250	19,5	≥38	CN12	58,00 €
SM04832	SM04757	S32T TCLNR/L-12	32	30	300	24	≥40	CN12	78,00 €
SM04788	SM04795	S40U TCLNR/L-12	40	37	350	30	≥50	CN12	96,00 €
SM04849	SM04863	S40U TCLNR/L-16	40	37	350	30	≥44	CN16	96,00 €
SM04771	SM04801	S50V TCLNR/L-12	50	47	400	38	≥63	CN12	120,00 €

Zubehör	PRATZE	PRATZENSCHRAUBE	UNTERLEGPLATTE	UP-SCHRAUBE	FEDERSCHNEIBE
S20R	TSK6 - 9106	TSBV M5x18 - 9201 (SW3)			
Ab S25S	TSK1 - 9101	TSBV M6x30 - 9205 (SW3)	BAX CN12-9603	TSAV M4x10 - 9403 (SW3)	TSP 6,5x12 - 9705

DN..

NEGATIVE WENDESCHNEIDPLATTE

ABMESSUNGEN

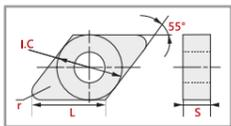
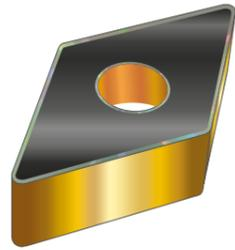

	r	L	I.C	S
DN.. 110404	0,4	11	9,53	4,76
DN.. 110408	0,8	11	9,53	4,76
DN.. 110412	1,2	11	9,53	4,76
DN.. 150604	0,4	15	12,7	6,35
DN.. 150608	0,8	15	12,7	6,35
DN.. 150612	1,2	15	12,7	6,35
DN.. 150616	1,6	15	12,7	6,35

P DNMG FÜR DIE STAHLBEARBEITUNG

Art. Nr.	Schlichtbearbeitung	
1661361	DNMG 150604-FP RT150+	5,70 €
1661362	DNMG 150608-FP RT150+	5,70 €

Art. Nr.	Mittlere Bearbeitung	
1661351	DNMG 110404-PM RT250+	4,90 €
1661352	DNMG 110408-PM RT250+	4,90 €
1661353	DNMG 110412-PM RT250+	4,90 €
1661354	DNMG 150604-PM RT250+	5,70 €
1661355	DNMG 150608-PM RT250+	5,70 €
1661356	DNMG 150612-PM RT250+	5,70 €
1661357	DNMG 150616-PM RT250+	5,70 €

Art. Nr.	Schrupp- & Mittlere Bearbeitung	
1661151	DNMG 150604 R RT250	5,70 €
1661152	DNMG 150604 L RT250	5,70 €
1661153	DNMG 150608 R RT250	5,70 €
1661154	DNMG 150608 L RT250	5,70 €

M DNMG FÜR DIE EDELSTAHLBEARBEITUNG

Art. Nr.	Schlichtbearbeitung	
1661144	DNMG 110404-FE RT305	4,70 €
1661145	DNMG 110408-FE RT305	4,70 €
1661141	DNMG 150604-FE RT305	5,70 €
1661142	DNMG 150608-FE RT305	5,70 €
1661143	DNMG 150612-FE RT305	5,70 €

Art. Nr.	Mittlere Bearbeitung	
1661611	DNMG 110404-MM RT250M	4,70 €
1661612	DNMG 110408-MM RT250M	4,70 €
1661621	DNMG 150604-MM RT250M	5,70 €
1661622	DNMG 150608-MM RT250M	5,70 €

Art. Nr.	Schrupp- & Mittlere Bearbeitung	
1661161	DNMG 150604-R RT305	5,70 €
1661162	DNMG 150604-L RT305	5,70 €
1661163	DNMG 150608-R RT305	5,70 €
1661164	DNMG 150608-L RT305	5,70 €

S DN.. FÜR SONDERWERKSTOFFE

Art. Nr.	Schlichtbearbeitung	
1661581	DNGG 150604-SF RT110S	7,90 €
1661582	DNGG 150608-SF RT110S	7,90 €

Art. Nr.	Mittlere Bearbeitung	
1661583	DNMG 150608-SM RT110S	6,10 €
1661584	DNMG 150612-SM RT110S	6,10 €

Art. Nr.	Schruppbearbeitung	
1661585	DNMG 150608-SR RT110S	6,10 €
1661586	DNMG 150612-SR RT110S	6,10 €

N DNMG FÜR NE-METALLE

Art. Nr.		
1661631	DNMG 150604-ALZ RT100	5,70 €
1661632	DNMG 150608-ALZ RT100	5,70 €

H DNGA - CBN FÜR GEHÄRTETEN STAHL

Art. Nr.	CBN 2 Schneiden	
1661596	DNGA 150604-2N RTC20T	29,50 €
1661597	DNGA 150608-2N RTC20T	29,50 €

2 Schneiden

PDJNR/L (93°) FÜR DN.. - LÄNGSDREHEN/PROFILDREHEN



Abbildung zeigt R

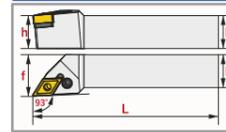

Art. Nr. R	Art. Nr. L		h=H	B	L	f	Platte	
1111081	1111082	PDJNR/L 1616 H11	16	16	100	20	DN11	34,00 €
1111083	1111084	PDJNR/L 2020 K11	20	20	125	25	DN11	35,00 €
1111085	1111086	PDJNR/L 2525 M11	25	25	150	32	DN11	37,00 €
SM01794	SM01800	PDJNR/L 2020 K15	20	20	125	25	DN15	39,00 €
SM01817	SM01824	PDJNR/L 2525 M15	25	25	150	32	DN15	39,00 €
1111065	1111066	PDJNR/L 3225 P15	32	25	170	38	DN15	44,00 €

Zubehör	KNIEHEBEL	KNIEHEBELSCHRAUBE	UNTERLEGPLATTE	ROHRSTIFT
	SPL4 - 9123	SLV4 M8x21 9229 (SW3)	BAX DN15-9602	SLAY1 - 9701

TDJNR/L (93°) FÜR DN.. - LÄNGSDREHEN



Abbildung zeigt R

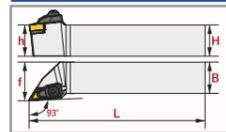

Art. Nr. R	Art. Nr. L		h=H	B	L	f	Platte	
SM00421	SM00469	TDJNR/L 2020 K15	20	20	125	26	DN15	45,00 €
SM00438	SM00483	TDJNR/L 2525 M15	25	25	150	32	DN15	47,00 €

Zubehör	PRATZE	PRATZENSCHRAUBE	UNTERLEGPLATTE	UP-SCHRAUBE	FEDERSCHEIBE
	TSK1 - 9101	TSBV M6x30 - 9205 (SW3)	BAX DN15-9602	TSAV M4x10 - 9403	TSP 6,5x12 - 9705

PDUNR/L (93°) FÜR DN.. - PROFILDREHEN



Abbildung zeigt R

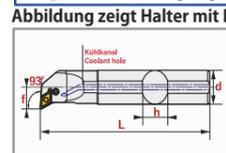

Art. Nr. R	Art. Nr. L		d	h	L	f	Dmin	Platte	
1111091	1111092	S20Q PDUNR/L 11	20	18	180	13	≥25	DN11	65,50 €
1111093	1111094	S20S PDUNR/L 11	20	18	250	13	≥25	DN11	69,00 €
1111095	1111096	S25Q PDUNR/L 11	25	23	180	17	≥32	DN11	67,00 €
1111097	1111098	S25T PDUNR/L 11	25	23	300	17	≥32	DN11	86,00 €
1111099	1111100	S32R PDUNR/L 11	32	30	200	22	≥40	DN11	88,00 €
1111101	1111102	S32U PDUNR/L 11	32	30	350	22	≥40	DN11	99,00 €
1111103	1111104	A25R PDUNR/L 11*	25	24	200	17	≥32	DN11	77,00 €
SM06072	SM06089	S32T PDUNR/L 15	32	30	300	22	≥40	DN15	76,00 €
SM06119	SM06126	S40U PDUNR/L 15	40	37,5	350	27	≥50	DN15	96,00 €
SM37663	SM37670	S50V PDUNR/L 15	50	47	400	35	≥63	DN15	119,00 €
SM40328	SM40335	A32S PDUNR/L 15*	32	30	250	22	≥40	DN15	96,00 €

* = mit Kühlkanal

Zubehör	KNIEHEBEL	KNIEHEBELSCHRAUBE	UNTERLEGPLATTE	ROHRSTIFT
	SPL4 - 9123	SLV2-M8x21 9225 (SW3)	BAX DN15-9602	SLAY1 - 9701

TDUNR/L (93°) FÜR DN.. - PROFILDREHEN



Abbildung zeigt R

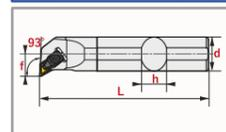

Art. Nr. R	Art. Nr. L		d	h	L	f	Dmin	Platte	
SM04887	SM04924	S25S TDUNR/L 11	25	23	250	19,5	≥33	DN11	54,00 €
SM04917	SM04955	S32T TDUNR/L 11	32	30	300	24	≥40	DN11	69,00 €
SM05044	SM04986	S25S TDUNR/L 15	25	23	250	19,5	≥39	DN15	58,00 €
SM05075	SM04993	S32T TDUNR/L 15	32	30	300	24	≥40	DN15	78,00 €
SM05099	SM05013	S40U TDUNR/L 15	40	37	350	30	≥50	DN15	96,00 €

Zubehör	PRATZE	PRATZENSCHRAUBE	UNTERLEGPLATTE	UP-SCHRAUBE	FEDERSCHEIBE
S25S... 11	TSK2 - 9102	TSBV M5x18 - 9201 (SW3)	BAX DN11-9601	TSAV M4x10x6 - 9402	
S32T... 11	TSK2 - 9102	TSBV M5x24 - 9202 (SW3)	BAX DN11-9601	TSAV M4x10x6 - 9402	
S.. 15	TSK1 - 9101	TSBV M6x30 - 9205 (SW3)	BAX DN15-9602	TSAV M4x10 - 9403	TSP 6,5x12 - 9705

WN..

NEGATIVE WENDESCHNEIDPLATTE

ABMESSUNGEN

	r	L	I.C	S
WN.. 060404	0,4	6,5	9,525	4,76
WN.. 060408	0,8	6,5	9,525	4,76
WN.. 060412	1,2	6,5	9,525	4,76
WN.. 080404	0,4	8,7	12,7	4,76
WN.. 080408	0,8	8,7	12,7	4,76
WN.. 080412	1,2	8,7	12,7	4,76

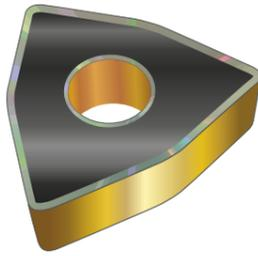
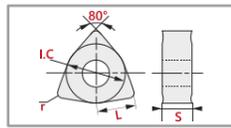

P WNMG FÜR DIE STAHLBEARBEITUNG

Art. Nr.	Mittlere Bearbeitung
1661411	WNMG 060404-PM RT225+ 3,90 €
1661412	WNMG 060408-PM RT225+ 3,90 €
1661413	WNMG 080404-PM RT250+ 4,40 €
1661414	WNMG 080408-PM RT250+ 4,40 €
1661415	WNMG 080412-PM RT250+ 4,40 €

M WNMG FÜR DIE EDELSTAHLBEARBEITUNG

Art. Nr.	Schlichtbearbeitung
1661323	WNMG 060404-FE RT305 3,90 €
1661324	WNMG 060408-FE RT305 3,90 €
1661321	WNMG 080404-FE RT305 4,40 €
1661322	WNMG 080408-FE RT305 4,40 €

Art. Nr.	Mittlere Bearbeitung
1661641	WNMG 080404-MA RT250M 4,40 €
1661642	WNMG 080408-MA RT250M 4,40 €

Art. Nr.	Schruppbearbeitung
1661651	WNMG 060404-MR RT255M 4,30 €
1661652	WNMG 060408-MR RT255M 4,30 €
1661653	WNMG 060412-MR RT255M 4,30 €
1661654	WNMG 080404-MR RT255M 4,80 €
1661655	WNMG 080408-MR RT255M 4,80 €
1661656	WNMG 080412-MR RT255M 4,80 €

K WNMG FÜR GUSS

Art. Nr.	Mittlere Bearbeitung
1661451	WNMG 080404-KC RT150K 4,40 €
1661452	WNMG 080408-KC RT150K 4,40 €
1661453	WNMG 080412-KC RT150K 4,40 €

N WNMG FÜR NE-METALLE

Art. Nr.	
1661171	WNMG 080404-ALP RT100 4,20 €
1661172	WNMG 080408-ALP RT100 4,20 €

H WNGA - CBN FÜR GEHÄRTETEN STAHL

Art. Nr.	CBN 3 Schneiden
1661601	WNGA 080404-3N RTC20T 36,90 €
1661602	WNGA 080408-3N RTC20T 36,90 €

3 Schneiden



Abbildung zeigt R

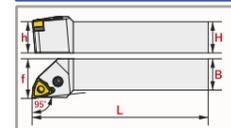

PWLNR/L (95°) FÜR WN.. - PLAN- UND LÄNGSDREHEN

Art. Nr. R	Art. Nr. L		h=H	B	L	f	Platte	
1111071	1111072	PWLNR/L 1616 H06	16	16	100	20	WN06	37,00 €
1111073	1111074	PWLNR/L 2020 K06	20	20	125	25	WN06	38,00 €
1111075	1111076	PWLNR/L 2525 M06	25	25	150	32	WN06	39,00 €
SM01985	SM01992	PWLNR/L 2020 K08	20	20	125	26	WN08	45,00 €
SM02005	SM02012	PWLNR/L 2525 M08	25	25	150	32	WN08	47,00 €

Zubehör

	KNIEHEBEL	KNIEHEBELSCHRAUBE	UNTERLEGPLATTE	ROHRSTIFT
WN06..	L3	LEM6x13,4A (SW2,5)	W06AP	SP3
WN08..	SPL1 - 9120	SLV1 M8x20 - 9224 (SW3)	BAX WN08-9607	SLAY1 - 9701



Abbildung zeigt R

Abbildung zeigt Halter mit IK

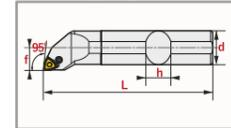

PWLNR/L (95°) FÜR WN.. - INNENAUSDREHEN/PLANDREHEN

Art. Nr. R	Art. Nr. L		d	h	L	f	Dmin	Platte	
1220111	1220112	S16M PWLNR/L-06	16	15	150	11	≥40	WN06	57,00 €
1220115	1220116	S20Q PWLNR/L-06	20	18	180	13	≥32	WN06	67,00 €
1220119	1220120	S25Q PWLNR/L-06	25	23	180	17	≥40	WN06	69,00 €
SM06256	SM06263	S25S PWLNR/L-08	25	23	250	17	≥32	WN08	56,00 €
SM06270	SM06287	S32T PWLNR/L-08	32	30	300	22	≥40	WN08	75,00 €
SM40250	SM40267	A25R PWLNR/L-08*	25	23	200	17	≥32	WN08	66,00 €
SM40236	SM40243	A32S PWLNR/L-08*	32	30	250	22	≥40	WN08	89,00 €

* = mit Kühlkanal

Zubehör

	KNIEHEBEL	KNIEHEBELSCHRAUBE	UNTERLEGPLATTE	ROHRSTIFT
WN06..	L3B	LEM5x12B (T09)		
WN08..	SPL1 - 9120	SLV1 M8x20 - 9224 (SW3)	BAX WN08-9607	SLAY1 - 9701



Abbildung zeigt R

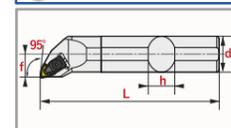

TWLNR/L (95°) FÜR WN.. - INNENAUSDREHEN/PLANDREHEN

Art. Nr. R	Art. Nr. L		d	h	L	f	Dmin	Platte	
SM50471	SM50488	S20R TWLNR/L-06	20	18	170	15	≥26	WN06	55,00 €
SM05488	SM05495	S25S TWLNR/L-06	25	23	250	19,5	≥36	WN06	58,00 €
SM05518	SM05501	S32T TWLNR/L-06	32	30	300	24	≥44	WN06	78,00 €
SM05532	SM05570	S25S TWLNR/L-08	25	23	250	19,5	≥38	WN08	58,00 €
SM05549	SM05525	S32T TWLNR/L-08	32	30	300	24	≥44	WN08	78,00 €
SM05556	SM05587	S40U TWLNR/L-08	40	37	350	30	≥50	WN08	96,00 €

Zubehör

	PRATZE	PRATZENSCHRAUBE	UNTERLEGPLATTE	UP-SCHRAUBE	FEDERSCHEIBE
WN06 - S20	TSK7- 9125	TSBV M5x18 - 9201 (SW3)	---	---	---
WN06 - S25	TSK2- 9102	TSBV M5x24 - 9202 (SW3)	BAX WN06-9606	CSAV M3x8 - 9401	---
WN06 - S32	TSK2- 9102	TSBV M5x24 - 9202 (SW3)	BAX WN06-9606	CSAV M3x8 - 9401	---
WN08	TSK1- 9101	TSBV M6x30 - 9205 (SW3)	BAX WN08-9607	TSAV M4x10 - 9403	TSP 6,5x12 - 9705

SN..

NEGATIVE WENDESCHNEIDPLATTE

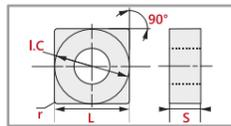
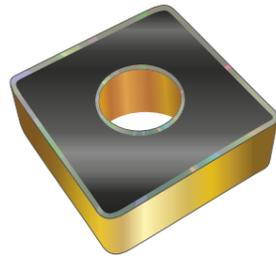

ABMESSUNGEN

	r	L	Lc	S
SN.. 120404	0,4	12,7	12,7	4,76
SN.. 120408	0,8	12,7	12,7	4,76
SN.. 120412	1,2	12,7	12,7	4,76
SN.. 150608	0,8	15,875	15,875	6,35
SN.. 150612	1,2	15,875	15,875	6,35
SN.. 150616	1,6	15,875	15,875	6,35
SN.. 190608	0,8	19,05	19,05	6,35
SN.. 190612	1,2	19,05	19,05	6,35
SN.. 190616	1,6	19,05	19,05	6,35
SN.. 190624	2,4	19,05	19,05	6,35

P SNMG FÜR DIE STAHLBEARBEITUNG

Art. Nr.	Mittlere Bearbeitung	
1661381	SNMG 120404-PM RT225+	4,40 €
1661382	SNMG 120408-PM RT225+	4,40 €
1661383	SNMG 120412-PM RT225+	4,40 €
1661385	SNMG 150608-PM RT225+	6,60 €
1661386	SNMG 150612-PM RT225+	6,60 €
1661661	SNMG 150616-PM RT225+	6,90 €
1661662	SNMG 190608-PM RT225+	8,40 €
1661663	SNMG 190612-PM RT225+	8,40 €
1661664	SNMG 190616-PM RT225+	8,40 €
1661665	SNMG 190624-PM RT225+	8,40 €

K SNMG FÜR GUSS

Art. Nr.	Mittlere Bearbeitung	
1661431	SNMG 120408-KC RT150K	4,60 €
1661432	SNMG 120412-KC RT150K	4,60 €

M SNMG FÜR DIE EDELSTAHLBEARBEITUNG

Art. Nr.	Schlichtbearbeitung	
1661461	SNMG 120404-FE RT305	4,20 €
1661462	SNMG 120408-FE RT305	4,20 €
1661463	SNMG 120412-FE RT305	4,20 €

Art. Nr.	Mittlere Bearbeitung	
1661471	SNMG 120408-ME RT305	4,20 €
1661472	SNMG 120412-ME RT305	4,20 €

Art. Nr.	Schruppbearbeitung	
1661671	SNMG 120404-MR RT255M	4,80 €
1661672	SNMG 120408-MR RT255M	4,80 €
1661673	SNMG 120412-MR RT255M	4,80 €

PSBNR/L (75°) FÜR SN.. - LÄNGSDREHEN

Art. Nr. R	Art. Nr. L	h=H	B	L	f	Platte		
SM34303	SM34310	PSBNR/L 2020 K12	20	20	125	17	SN12	45,00 €
SM22423	SM22430	PSBNR/L 2525 M12	25	25	150	23	SN12	47,00 €

Zubehör

SPL1 - 9120	SLV1 M8x20 9224 (SW3)	BAX SN12 - 9608	SLAY - 9701

PSKNR/L (75°) FÜR SN.. - PLANDREHEN

Art. Nr. R	Art. Nr. L	h=H	B	L	f	Platte		
SM26025	SM26018	PSKNR 2020 K12	20	20	125	26	SN12	45,00 €
SM22386	SM22393	PSKNL 2525 M12	25	25	150	32	SN12	47,00 €

Zubehör

SPL1 - 9120	SLV1 M8x20 9224 (SW3)	BAX SN12 - 9608	SLAY - 9701

PSSNR/L (45°) FÜR SN.. - PLANDREHEN

Art. Nr. R	Art. Nr. L	h=H	B	L	f	Platte		
SM01855	SM01862	PSSNR/L 2020 K12	20	20	125	26	SN12	45,00 €
SM01886	SM01893	PSSNR/L 2525 M12	25	25	150	32	SN12	47,00 €

Zubehör

SPL1 - 9120	SLV1 M8x20 9224 (SW3)	BAX SN12 - 9608	SLAY - 9701

PSKNR/L (75°) FÜR SN.. - INNENAUSDREHEN

Art. Nr. R	Art. Nr. L	d	h	L	f	Dmin	Platte		
SM06157	SM06164	S25S PSKNR/L 12	25	23	250	17	≥32	SN12	58,00 €
SM06171	SM06188	S32T PSKNR/L 12	32	30	300	22	≥40	SN12	75,00 €
SM06195	SM06201	S40U PSKNR/L 12	40	37	350	27	≥50	SN12	96,00 €
SM49376	SM49383	A25R PSKNR/L 12 *	25	23	200	17	≥32	SN12	66,00 €
SM49390	SM49406	A32S PSKNR/L 12 *	32	30	250	22	≥40	SN12	90,00 €

* = mit Kühlkanal

Zubehör

SPL1 - 9120	SLV1 M8x20 9224 (SW3)	BAX SN12 - 9608	SLAY - 9701

Abbildung zeigt Halter mit IK



Abbildung zeigt R



Abbildung zeigt R

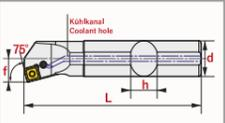

Abbildung zeigt R



Abbildung zeigt R

KN..

NEGATIVE WENDESCHNEIDPLATTE

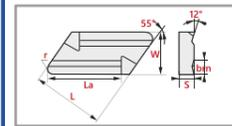
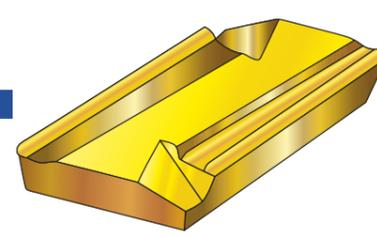

ABMESSUNGEN

	r	La	brn	L	W	S
KNUX 160405	0,5	16	2,2	16,15	9,525	4,76
KNUX 160410	1,0	16	2,2	16,15	9,525	4,76



Rechts

P KNUX RECHTS FÜR DIE STAHLBEARBEITUNG

Art. Nr.	Schrupp- und mittlere Bearbeitung	
1771152	KNUX 160405 R11 RT250	3,60 €
1771154	KNUX 160410 R11 RT250	3,60 €



Abbildung zeigt R

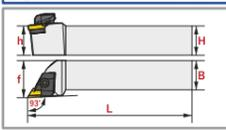

CKJNR/L (93°) FÜR CN.. - LÄNGSDREHEN/PROFILDREHEN

Art. Nr.		h=H	B	L	f	Platte	
SM02081	CKJNR 2020 K16	20	20	125	25	KNUX 16 R	44,00 €
SM02098	CKJNR 2525 M16	25	25	150	31	KNUX 16 R	44,00 €

Zubehör

2020 CSK3/R - 9117	BKTV M6x26- 9233 (SW5)	BAX KN16/R-9621	CSAV M3x8 - 9401 (SW2)
2525 CSK/R - 9112	CSBV1 M6x26- 9223 (SW5)	BAX KN16/R-9621	CSAV M3x8 - 9401 (SW2)



Links

P KNUX LINKS FÜR DIE STAHLBEARBEITUNG

Art. Nr.	Schrupp- und mittlere Bearbeitung	
1771151	KNUX 160405 L11 RT250	3,60 €
1771153	KNUX 160410 L11 RT250	3,60 €



Abbildung zeigt R

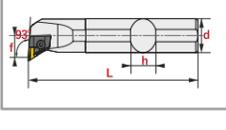

CKUNR/L (93°) FÜR CN.. - INNENAUSDREHEN

Art. Nr. R		d	h	L	f	Dmin	Platte	
SM20771	S25S CKUNR 16	25	23	250	19	≥34	KNUX 16 L	53,00 €
SM20818	S32T CKUNR 16	32	30	300	22	≥40	KNUX 16 L	62,00 €
SM20832	S40U CKUNR 16	40	37	350	27	≥50	KNUX 16 L	83,00 €

Zubehör

S25S CSK1/R - 9111	CSBV M6x20- 9209 (SW4)	BAX KN16/R-9621	CSAV M3x8 - 9401 (SW2)
S32T/S40U CSK2/R - 9113	CSBV1 M6x26- 9223 (SW5)	BAX KN16/R-9621	CSAV M3x8 - 9401 (SW2)

P Stahl

M Edelstahl

K Guss

S Sonderwerkstoffe

H Harte Werkstoffe

N NE-Metalle

Komplette Träger-Zubehörliste mit Art. Nr. und Preise auf Seite 81.



SN..



KN..

CC..

POSITIVE WENDESCHNEIDPLATTE

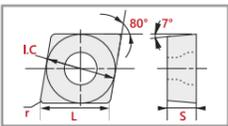
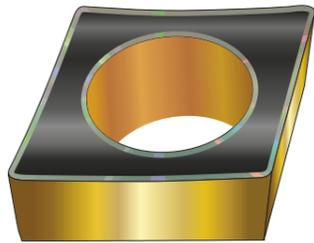

ABMESSUNGEN

	r	L	l.c	s
CC.. 060202	0,2	6,4	6,35	2,38
CC.. 060204	0,4	6,4	6,35	2,38
CC.. 060208	0,8	6,4	6,35	2,38
CC.. 09T302	0,2	9,7	9,525	3,97
CC.. 09T304	0,4	9,7	9,525	3,97
CC.. 09T308	0,8	9,7	9,525	3,97
CC.. 09T312	1,2	9,7	9,525	3,97
CC.. 120404	0,4	12,9	12,7	4,76
CC.. 120408	0,8	12,9	12,7	4,76

P CCMT FÜR DIE STAHLBEARBEITUNG

Art. Nr.	Mittlere Bearbeitung	
1771621	CCMT 060204-PM RT250+	2,95 €
1771622	CCMT 09T304-PM RT250+	3,49 €
1771623	CCMT 09T308-PM RT250+	3,49 €

Art. Nr.	Schruppbearbeitung	
1771631	CCMT 09T304-PR RT250+	3,49 €
1771632	CCMT 09T308-PR RT250+	3,49 €

N CCGT FÜR NE-METALLE

Art. Nr.		
1771001	CCGT 060202-ALZ RT100	3,00 €
1771002	CCGT 060204-ALZ RT100	3,00 €
1771003	CCGT 060208-ALZ RT100	3,00 €
1771004	CCGT 09T302-ALZ RT100	3,30 €
1771005	CCGT 09T304-ALZ RT100	3,30 €
1771006	CCGT 09T308-ALZ RT100	3,30 €
1771007	CCGT 120404-ALZ RT100	3,80 €
1771008	CCGT 120408-ALZ RT100	3,80 €

M N CCGT FÜR EDELSTAHL UND NE-METALLE

Art. Nr.		
1771024	CCGT 060202-ALM RT105C	4,40 €
1771025	CCGT 060204-ALM RT105C	4,40 €
1771021	CCGT 09T302-ALM RT105C	4,60 €
1771022	CCGT 09T304-ALM RT105C	4,60 €
1771023	CCGT 09T308-ALM RT105C	4,60 €
1771026	CCGT 120404-ALM RT105C	4,80 €
1771027	CCGT 120408-ALM RT105C	4,80 €

P M CCMT FÜR STAHL UND EDELSTAHL

Art. Nr.	Mittlere Bearbeitung	
1771051	CCMT 060202-HM RT300	2,95 €
1771052	CCMT 060204-HM RT300	2,95 €
1771053	CCMT 060208-HM RT300	2,95 €
1771054	CCMT 09T302-HM RT300	3,49 €
1771055	CCMT 09T304-HM RT300	3,49 €
1771056	CCMT 09T308-HM RT300	3,49 €
1771057	CCMT 120404-HM RT300	4,40 €
1771058	CCMT 120408-HM RT300	4,40 €

N CC.. - PKD FÜR HIGH SPEED ALUBEARBEITUNG

Art. Nr.	mit Spanformer	
1771586	C-CCGW 060202-1N RTD10	1031,90 €
1771587	C-CCGW 09T304-1N RTD10	1031,90 €

Art. Nr.	mit 7° positivem Spanwinkel	
1771591	CCGT 060202-1N RTD10	22,95 €
1771592	CCGT 060204-1N RTD10	22,95 €
1771593	CCGT 09T302-1N RTD10	22,95 €
1771594	CCGT 09T304-1N RTD10	22,95 €
1771595	CCGT 09T308-1N RTD10	22,95 €

H CCGW - CBN FÜR GEHÄRTETEN STAHL

Art. Nr.	CBN 2 Schneiden	
1771461	CCGW 060202-2N RTC20T	29,50 €
1771462	CCGW 060204-2N RTC20T	29,50 €
1771463	CCGW 060208-2N RTC20T	29,50 €
1771471	CCGW 09T302-2N RTC20T	29,50 €
1771472	CCGW 09T304-2N RTC20T	29,50 €
1771473	CCGW 09T308-2N RTC20T	29,50 €
1771474	CCGW 09T312-2N RTC20T	29,50 €
1771470	CCGW 120404-2N RTC20T	29,50 €
1771475	CCGW 120408-2N RTC20T	29,50 €

Art. Nr.	Flat	
1771581	CCGW 060202-1N RTD10	22,95 €
1771582	CCGW 060204-1N RTD10	22,95 €
1771583	CCGW 09T302-1N RTD10	22,95 €
1771584	CCGW 09T304-1N RTD10	22,95 €
1771585	CCGW 09T308-1N RTD10	22,95 €



Abbildung zeigt R

SCLCR/L (95°) FÜR CC.. - LÄNGSDREHEN/PLANDREHEN

Art. Nr. R	Art. Nr. L		h=H	B	L	f	Platte	
SM02296	SCLCR 1212 F09		12	12	80	15	CC09	39,00 €
SM02340	SM02302 SCLCR/L 1616 H09		16	16	100	20	CC09	39,00 €
SM02326	SM02319 SCLCR/L 2020 K09		20	20	125	25	CC09	39,00 €
SM02357	SM02333 SCLCR/L 2525 M09		25	25	150	29	CC09	39,00 €
SM02470	SM02487 SCLCR/L 2020 K12		20	20	125	25	CC12	39,00 €

Zubehör	SCHRAUBE	UNTERLEGPLATTE	UP-SCHRAUBE
1212 CC09	SSV M3,5x8 -9510 (T15)	---	---
1616 CC09	SSV M3,5x8 -9510 (T15)	BAX CC09 - 9616	SBV5 M5x0,5 A3,5x9 - 9408 (SW3,5)
2020-2525 CC09	M3,5x12 (T15)	BAX CC09 - 9616	SBV M5x0,5 A3,5x11 - 9407 (SW3,5)
2020 CC12	SSV M4x12x6 -9517 (T15)	BAX CC12 - 9617	SBV2 M6x0,75 A4x13 - 9410 (SW4,5)



Abbildung zeigt R

Abbildung zeigt Halter mit IK

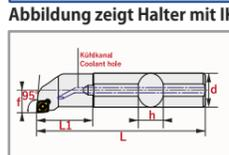

SCLCR/L (95°) FÜR CC.. - INNENAUSDREHEN/PLANDREHEN

Art. Nr. R	Art. Nr. L		d	h	L	L1	f	Dmin	Platte	
SM06393	SM06461 S0608H SCLCR/L 06		8*	7	100	25	05	≥8	CC06	23,00 €
SM06317	SM06362 S08H SCLCR/L 06		8	7	100	-	07	≥11	CC06	23,00 €
SM06324	SM06331 S10K SCLCR/L 06		10	9	125	-	08	≥13	CC06	25,00 €
SM06348	SM06355 S12K SCLCR/L 06		12	11	125	-	10	≥16	CC06	27,00 €
SM06386	SM26049 S16x10M SCLCR/L 06		16	15	150	35	8	≥13	CC06	34,00 €
SM37793	SM37809 S12K SCLCR/L 09		12	11	125	-	10	≥16	CC09	27,00 €
SM06478	SM06485 S16P SCLCR/L 09		16	15	170	-	13	≥21	CC09	29,00 €
SM06492	SM06508 S20R SCLCR/L 09		20	19	200	-	15	≥25	CC09	35,00 €
SM06515	SM06522 S25S SCLCR/L 09		25	23	250	-	19,5	≥32	CC09	42,00 €
SM06539	SM06546 S32T SCLCR/L 09		32	30	300	-	24	≥40	CC09	72,00 €
SM36376	SM36383 A08H SCLCR/L 06	*	8	7	100	-	7	≥11	CC06	29,00 €
SM36390	SM36406 A10H SCLCR/L 06	*	10	9	100	-	8	≥13	CC06	29,00 €
SM36413	SM36420 A12H SCLCR/L 06	*	12	11	100	-	10	≥16	CC06	32,00 €
SM36437	SM36444 A16M SCLCR/L 09	*	16	15	150	-	13	≥21	CC09	39,00 €
SM36451	SM36468 A20P SCLCR/L 09	*	20	19	170	-	15	≥25	CC09	40,00 €
SM36475	SM36482 A25R SCLCR/L 09	*	25	23	200	-	19,50	≥32	CC09	47,00 €

* = mit Kühlkanal

* = Halsdurchmesser 6 mm

Zubehör	SCHRAUBE	UNTERLEGPLATTE	UP-SCHRAUBE
S0608H-S08 CC06	SSV M2,5x5 -9504 (T08)	---	---
S10-S16x10M CC06	SSV M2,5x6 -9505 (T08)	---	---
S12K-S16P CC09	SSV M3,5x8 - 9510 (T15)	---	---
S20R CC09	SSV M3,5x10 - 9511 (T15)	---	---
S25S CC09	SSV M3,5x10 - 9511 (T15)	BAX CC09 - 9616	SBV5 M5x0,5 A3,5x9 - 9408 (SW3,5)
S32T CC09	SSV M3,5x14 - 9512 (T15)	BAX CC09 - 9616	SBV M5x0,5 A3,5x11 - 9407 (SW3,5)
A... CC06	SSV M2,5x6 - 9505 (T08)	---	---
A16M CC09	SSV M3,5x8 - 9510 (T15)	---	---
A20P CC09	SSV M3,5x10 - 9511 (T15)	---	---
A25R CC09	SSV M3,5x8 - 9510 (T15)	BAX CC09 - 9616	SBV5 M5x0,5 A3,5x9 - 9408 (SW3,5)



Abbildung zeigt R

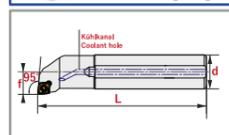

HARTMETALL-INNENDREHHALTER E-SCLCR/L (95°) FÜR CC.. - INNENAUSDREHEN/PLANDREHEN

Art. Nr. R	Art. Nr. L		d	L	f	Dmin	Platte	
SM60074	SM60135 E08K SCLCR/L 06	*	08	125	06	≥13	CC06	90,00 €
SM60081	SM60142 E10M SCLCR/L 06	*	10	150	08	≥16	CC06	129,00 €
SM60098	SM60159 E12Q SCLCR/L 06	*	12	180	10	≥21	CC06	185,00 €
SM60111	SM60173 E16R SCLCR/L 09	*	16	200	13	≥21	CC09	217,00 €

* = mit Kühlkanal

Zubehör	SCHRAUBE	UNTERLEGPLATTE	UP-SCHRAUBE
E08K	SSV M2,5x5 -9504 (T08)	---	---
E10M, E12Q	SSV M2,5x6 -9505 (T08)	---	---
E16R	SSV M3,5x8 -9510 (T15)	---	---

DC..

POSITIVE WENDESCHNEIDPLATTE

ABMESSUNGEN

	r	L	l.C	S
DC.. 070201	0,1	7,8	6,35	2,38
DC.. 070202	0,2	7,8	6,35	2,38
DC.. 070204	0,4	7,8	6,35	2,38
DC.. 070208	0,8	7,8	6,35	2,38
DC.. 11T302	0,2	11,6	9,525	3,97
DC.. 11T304	0,4	11,6	9,525	3,97
DC.. 11T308	0,8	11,6	9,525	3,97

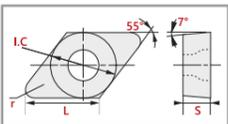
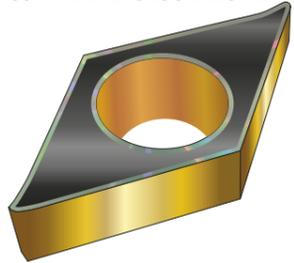

P DCMT FÜR DIE STAHLBEARBEITUNG

Art. Nr.	Mittlere Bearbeitung	Preis
1771643	DCMT 070204-PM RT250+	2,95 €
1771641	DCMT 11T304-PM RT250+	3,49 €
1771642	DCMT 11T308-PM RT250+	3,49 €

Art. Nr.	Schruppbearbeitung	Preis
1771651	DCMT 11T304-PR RT250+	3,49 €
1771652	DCMT 11T308-PR RT250+	3,49 €

N DCGT FÜR NE-METALLE

Art. Nr.	Preis	
1771077	DCGT 070201-ALZ RT100	3,00 €
1771071	DCGT 070202-ALZ RT100	3,00 €
1771072	DCGT 070204-ALZ RT100	3,00 €
1771073	DCGT 070208-ALZ RT100	3,00 €
1771074	DCGT 11T302-ALZ RT100	3,30 €
1771075	DCGT 11T304-ALZ RT100	3,30 €
1771076	DCGT 11T308-ALZ RT100	3,30 €

P M DCMT FÜR STAHL UND EDELSTAHL

Art. Nr.	Mittlere Bearbeitung	Preis
1771131	DCMT 070202-HM RT300	2,95 €
1771132	DCMT 070204-HM RT300	2,95 €
1771133	DCMT 070208-HM RT300	2,95 €
1771134	DCMT 11T302-HM RT300	3,49 €
1771135	DCMT 11T304-HM RT300	3,49 €
1771136	DCMT 11T308-HM RT300	3,49 €

M N DCGT FÜR EDELSTAHL UND NE-METALLE

Art. Nr.	Mittlere Bearbeitung/Schichten	Preis
1771094	DCGT 070202-ALM RT105C	4,30 €
1771095	DCGT 070204-ALM RT105C	4,30 €
1771096	DCGT 070208-ALM RT105C	4,30 €
1771091	DCGT 11T302-ALM RT105C	4,60 €
1771092	DCGT 11T304-ALM RT105C	4,60 €
1771093	DCGT 11T308-ALM RT105C	4,60 €

H DCGW - CBN FÜR GEHÄRTETEN STAHL

Art. Nr.	CBN 2 Schneiden	Preis
1771476	DCGW 070204-2N RTC20T	29,50 €
1771477	DCGW 070208-2N RTC20T	29,50 €
1771481	DCGW 11T302-2N RTC20T	29,50 €
1771482	DCGW 11T304-2N RTC20T	29,50 €
1771483	DCGW 11T308-2N RTC20T	29,50 €

N DC.. - PKD FÜR HIGH SPEED ALUBEARBEITUNG

Art. Nr.	mit 7° positivem Spanwinkel	Preis
1771571	DCGT 070202-1N RTD10	22,95 €
1771572	DCGT 070204-1N RTD10	22,95 €
1771573	DCGT 11T302-1N RTD10	22,95 €
1771574	DCGT 11T304-1N RTD10	22,95 €
1771575	DCGT 11T308-1N RTD10	22,95 €

Art. Nr.	Flat	Preis
1771561	DCGW 070202-1N RTD10	22,95 €
1771562	DCGW 070204-1N RTD10	22,95 €
1771563	DCGW 11T302-1N RTD10	22,95 €
1771564	DCGW 11T304-1N RTD10	22,95 €
1771565	DCGW 11T308-1N RTD10	22,95 €



SDJCR/L (93°) FÜR DC.. - PROFILDREHEN

Art. Nr. R	Art. Nr. L	h=H	B	L	f	Platte	Preis
SM02623	SDJCR 1010 E07	10	10	70	12	DC07	26,40 €
SM02562	SDJCR 1212 F07	12	12	80	15	DC07	26,40 €
SM02579	SDJCR 1616 H07	16	16	100	20	DC07	32,00 €
SM02760	SM02777 SDJCR/L 1616 H11	16	16	100	20	DC11	39,00 €
SM02791	SM02784 SDJCR/L 2020 K11	20	20	125	25	DC11	39,00 €
SM02821	SM02838 SDJCR/L 2525 M11	25	25	150	30	DC11	39,00 €

Zubehör	SCHRAUBE	UNTERLEGPLATTE	UP-SCHRAUBE
DC07	SSV M2,5x6 -9505 (T08)	---	---
1616 DC11	M3,5x12 (T15)	BAX DC11 - 9613	SBV5 M5x0,5 A3,5x9 - 9408 (SW3,5)
2020-2525 DC11	M3,5x12 (T15)	BAX DC11 - 9613	SBV M5x0,5 A3,5x11 - 9407 (SW3,5)



SDQCR/L (107,5°) FÜR DC.. - PROFILDREHEN

Art. Nr. R	Art. Nr. L	d	h	L	f	Dmin	Platte	Preis
SM06751	SM06799 S12K SDQCR/L 07	12	11	125	10	≥16	DC07	26,00 €
SM06911	SM06928 S16P SDQCR/L 07	16	15	170	13	≥21	DC07	29,00 €
SM07031	SM07291 S16P SDQCR/L 11	16	15	170	13	≥21	DC11	29,00 €
SM07093	SM07130 S20R SDQCR/L 11	20	18	200	15	≥25	DC11	33,00 €
SM07161	SM07192 S25S SDQCR/L 11	25	23	250	19,5	≥32	DC11	37,00 €
SM36239	SM36246 A10H SDQCR/L 07 *	10	09	100	08	≥13	DC07	29,00 €
SM36253	SM36260 A12H SDQCR/L 07 *	12	11	100	10	≥16	DC07	33,00 €
SM36277	SM36284 A16M SDQCR/L 07 *	16	15	150	13	≥21	DC07	36,00 €
SM36291	SM36307 A16M SDQCR/L 11 *	16	15	150	13	≥21	DC11	36,00 €
SM36314	SM36321 A20P SDQCR/L 11 *	20	18	170	15	≥25	DC11	39,00 €
SM36338	SM36345 A25R SDQCR/L 11 *	25	23	200	19,5	≥32	DC11	46,00 €
SM36352	SM36369 A32S SDQCR/L 11 *	32	30	250	24	≥40	DC11	72,00 €

* = mit Kühlkanal

Zubehör	SCHRAUBE	UNTERLEGPLATTE	UP-SCHRAUBE
DC07	SSV M2,5x6 -9505 (T08)	---	---
S16P, S20R, A16M, A20P	SSV M3,5x10 - 9511 (T15)	---	---
S25S, A25R	SSV M3,5x10 - 9511 (T15)	BAX DC11 - 9613	SBV5 M5x0,5 A3,5x9 - 9408 (SW3,5)
A32S	SSV M3,5x14 - 9512 (T15)	BAX DC11 - 9613	SBV M5x0,5 A3,5x11 - 9407 (SW3,5)



SDUCR/L (93°) FÜR DC.. - PROFILDREHEN

Art. Nr. R	Art. Nr. L	d	h	L	f	Dmin	Platte	Preis
SM06713	SM06805 S10K SDUCR/L 07	10	9	125	08	≥13	DC07	25,00 €
SM06744	SM06775 S12K SDUCR/L 07	12	11	125	10	≥16	DC07	27,00 €
SM06836	SM06904 S16P SDUCR/L 07	16	15	170	13	≥21	DC07	29,00 €
SM06836	SM06904 S16P SDUCR/L 07	16	15	170	13	≥21	DC07	29,00 €
SM42803	SM42810 S20R SDUCR/L 07	20	18	200	15	≥25	DC07	32,00 €
SM07017	SM07055 S16P SDUCR/L 11	16	15	170	13	≥21	DC11	29,00 €
SM07086	SM07116 S20R SDUCR/L 11	20	18	200	15	≥25	DC11	33,00 €
SM07147	SM07178 S25S SDUCR/L 11	25	23	250	19,5	≥32	DC11	37,00 €
SM36093	SM36109 A10H SDUCR/L 07 *	10	09	100	08	≥13	DC07	29,00 €
SM36116	SM36123 A12H SDUCR/L 07 *	12	11	100	10	≥16	DC07	33,00 €
SM36130	SM36147 A16M SDUCR/L 07 *	16	15	150	13	≥21	DC07	36,00 €
SM36154	SM36161 A16M SDUCR/L 11 *	16	15	150	13	≥21	DC11	36,00 €
SM36178	SM36185 A20P SDUCR/L 11 *	20	18	170	15	≥25	DC11	39,00 €
SM36192	SM36208 A25R SDUCR/L 11 *	25	23	200	19,50	≥32	DC11	46,00 €
SM36215	SM36222 A32S SDUCR/L 11 *	32	30	250	24	≥40	DC11	72,00 €

* = mit Kühlkanal

Zubehör	SCHRAUBE	UNTERLEGPLATTE	UP-SCHRAUBE
DC07	SSV M2,5x6 -9505 (T08)	---	---
DC11: S16P, S20R, A16M, A20P	SSV M3,5x10 - 9511 (T15)	---	---
DC11: S25S, A25R	SSV M3,5x10 - 9511 (T15)	BAX DC11 - 9613	SBV5 M5x0,5 A3,5x9 - 9408 (SW3,5)
DC11: S32T, A32S	SSV M3,5x14 - 9512 (T15)	BAX DC11 - 9613	SBV M5x0,5 A3,5x11 - 9407 (SW3,5)



SDXCR/L (93°) FÜR DC.. - RÜCKWÄRTSDREHEN

Art. Nr. R	Art. Nr. L	S	d	h	L	f	Dmin	Platte	Preis	
SM06768	SM06997	S12K	SDXCR/L 07	12	11	125	11	≥17	DC07	26,00 €
SM07048	SM07307	S16P	SDXCR/L 11	16	15	170	13	≥21	DC11	29,00 €
SM07109	SM07321	S20R	SDXCR/L 11	20	18	200	15	≥25	DC11	32,00 €

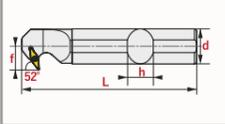

Zubehör

	SCHRAUBE	UNTERLEGPLATTE	UP-SCHRAUBE
DC07	SSV M2,5x6 -9505 (T08)	---	---
DC11	SSV M3,5x10 - 9511 (T15)	---	---



DC..



RC..



SC..



HARTMETALL-INNENDREHHALTER E-SDQCR/L (107,5°) FÜR DC.. - PROFILDREHEN

Art. Nr. R	Art. Nr. L	E	d	L	f	Dmin	Platte	Preis	
SM59979	SM60012	E10M	SDQCR/L-07 *	10	150	08	≥13	DC07	129,00 €
SM59986	SM60029	E12Q	SDQCR/L-07 *	12	180	10	≥16	DC07	185,00 €
SM59993	SM60036	E16R	SDQCR/L-11 *	16	200	13	≥21	DC11	217,00 €

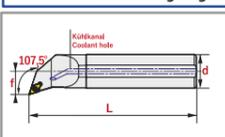

* = mit Kühlkanal

Zubehör

	SCHRAUBE	UNTERLEGPLATTE	UP-SCHRAUBE
E10M, E12Q	SSV M2,5x6 -9505 (T08)	---	---
E16R	SSV M3,5x10 -9511 (T15)	---	---



HARTMETALL-INNENDREHHALTER E-SDUCR/L (93°) FÜR DC.. - PROFILDREHEN

Art. Nr. R	Art. Nr. L	E	d	L	f	Dmin	Platte	Preis	
SM59771	SM59818	E10M	SDUCR/L-07 *	10	150	08	≥13	DC07	129,00 €
SM59788	SM59825	E12Q	SDUCR/L-07 *	12	180	10	≥16	DC07	185,00 €
SM59795	SM59832	E16R	SDUCR/L-11 *	16	200	13	≥21	DC11	217,00 €

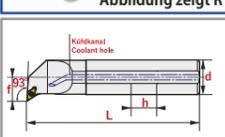

* = mit Kühlkanal

Zubehör

	SCHRAUBE	UNTERLEGPLATTE	UP-SCHRAUBE
E10M, E12Q	SSV M2,5x6 -9505 (T08)	---	---
E16R	SSV M3,5x10 -9511 (T15)	---	---

RC.. POSITIVE WENDESCHNEIDPLATTE

ABMESSUNGEN

	L	I.C	S	d
RC.. 0803MO	8	8	3,18	3,36
RC.. 10T3MO	10	10	3,97	3,6
RC.. 1204MO	12	12	4,76	4,44
RC.. 1606MO	16	16	6,35	5,5
RC.. 2006MO	20	20	6,35	6,5

P RCMT FÜR DIE STAHLBEARBEITUNG

Art. Nr.	Mittlere Bearbeitung	Preis
1771421	RCMT 0803MO RT250+	3,90 €
1771422	RCMT 10T3MO RT250+	4,20 €
1771423	RCMT 1204MO RT250+	4,50 €
1771424	RCMT 1606MO RT250P	6,80 €
1771425	RCMT 2006MO RT250P	8,90 €

N RCGT FÜR NE-METALLE

Art. Nr.	Mittlere Bearbeitung	Preis
1771171	RCGT 0803MO-ALZ RT100	3,20 €
1771173	RCGT 10T3MO-ALZ RT100	3,40 €
1771174	RCGT 1204MO-ALZ RT100	3,40 €

SRDCN FÜR RC.. - LÄNGSDREHEN

Art. Nr.	h=H	B	L	f	Platte	Preis
SM03033	16	16	100	08	RC08	36,00 €
SM02968	20	20	125	10	RC08	36,00 €
SM02975	25	25	150	12,5	RC08	39,00 €
SM03187	16	16	100	08	RC10	36,00 €
SM03064	20	20	125	10	RC10	36,00 €
SM03071	25	25	150	12,5	RC10	39,00 €
SM03224	20	20	125	10	RC12	36,00 €
SM03231	25	25	150	12,5	RC12	39,00 €
SM03293	32	32	170	16	RC12	44,00 €

Zubehör

	SCHRAUBE	UNTERLEGPLATTE	UP-SCHRAUBE
RC08	SSV M3x6 -9507 (T08)	---	---
RC10 & RC12	M3,5x12 (T15)	---	---

SC.. POSITIVE WENDESCHNEIDPLATTE

ABMESSUNGEN

	r	L	I.C	S
SC.. 09T302	0,2	9,525	9,525	3,97
SC.. 09T304	0,4	9,525	9,525	3,97
SC.. 09T308	0,8	9,525	9,525	3,97
SC.. 120404	0,4	12,7	12,7	3,97
SC.. 120408	0,8	12,7	12,7	3,97

P SCMT FÜR DIE STAHLBEARBEITUNG

Art. Nr.	Mittlere Bearbeitung	Preis
1771626	SCMT 09T304-PM RT250+	3,49 €
1771627	SCMT 09T308-PM RT250+	3,49 €

M N SCGT FÜR EDELSTAHL UND NE-METALLE

Art. Nr.	Mittlere Bearbeitung	Preis
1771401	SCGT 09T302-ALM RT105	4,60 €
1771402	SCGT 09T304-ALM RT105	4,60 €
1771404	SCGT 120408-ALM RT105	5,20 €

N SCGT FÜR NE-METALLE

Art. Nr.	Mittlere Bearbeitung	Preis
1771191	SCGT 09T304-ALZ RT100	3,30 €
1771192	SCGT 09T308-ALZ RT100	3,30 €
1771193	SCGT 120404-ALZ RT100	3,80 €
1771194	SCGT 120408-ALZ RT100	3,80 €

VB.. POSITIVE WENDESCHNEIDPLATTE

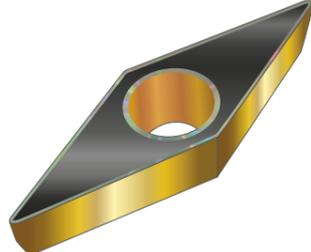

ABMESSUNGEN

	r	L	I.C	S
VB.. 160402	0,2	16,5	9,525	4,76
VB.. 160404	0,4	16,5	9,525	4,76
VB.. 160408	0,8	16,5	9,525	4,76
VB.. 160412	1,2	16,5	9,525	4,76

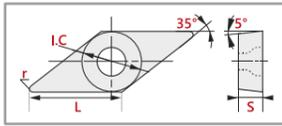

P VBMT FÜR DIE STAHLBEARBEITUNG

Art. Nr.	Schlichtbearbeitung	
1661214	VBMT 160404-PF RT150+	5,50 €
1661216	VBMT 160408-PF RT150+	5,50 €

Art. Nr.	Mittlere Bearbeitung	
1771311	VBMT 160404-PM RT250+	5,50 €
1771312	VBMT 160408-PM RT250+	5,50 €
1771313	VBMT 160412-PM RT250+	5,50 €

M VBMT FÜR DIE EDELSTAHLBEARBEITUNG

Art. Nr.	Schlichtbearbeitung	
1771441	VBMT 160402-MF RT255M	5,70 €
1771442	VBMT 160404-MF RT255M	5,70 €
1771443	VBMT 160408-MF RT255M	5,70 €

Art. Nr.	Mittlere Bearbeitung	
1771451	VBMT 160404-MM RT255M	5,70 €
1771452	VBMT 160408-MM RT255M	5,70 €

H VBGW - CBN FÜR GEHÄRTETEN STAHL

Art. Nr.	CBN 2 Schneiden	
1771501	VBGW 160402-2N RTC20T	29,50 €
1771502	VBGW 160404-2N RTC20T	29,50 €
1771503	VBGW 160408-2N RTC20T	29,50 €

N VB.. - PKD FÜR HIGH SPEED ALUBEARBEITUNG

Art. Nr.	Flat	
1771541	VBGW 160402-1N RTD10	22,95 €
1771542	VBGW 160404-1N RTD10	22,95 €
1771543	VBGW 160408-1N RTD10	22,95 €

Art. Nr.	mit 7° positivem Spanwinkel	
1771551	VBGT 160402-1N RTD10	22,95 €
1771552	VBGT 160404-1N RTD10	22,95 €
1771553	VBGT 160408-1N RTD10	22,95 €

SVHBR/L (107,5°) FÜR VB.. - PROFILDREHEN

Art. Nr. R	Art. Nr. L	h=H	B	L	f	Platte	
SM04450	SM04412	20	20	125	25	VB11	37,00 €
SM04573	SM04467	20	20	125	25	VB16	39,00 €
SM04665	SM04481	25	25	150	30	VB16	39,00 €

Zubehör

	SCHRAUBE	UNTERLEGPLATTE	UP-SCHRAUBE
VB11	SSV M2,5x6 - 9505 (T08)	---	---
VB16	SSV M3,5x14 - 9512 (T15)	BAX VB16 - 9618	SBV M5x0,5 A3,5x11 - 9407 (SW3,5)

SVJBR/L (93°) FÜR VB.. - PROFILDREHEN

Art. Nr. R	Art. Nr. L	h=H	B	L	f	Platte	
SM04504	SM04511	16	16	100	20	VB16	39,00 €
SM04566	SM04542	20	20	125	25	VB16	39,00 €
SM04597	SM04580	25	25	150	30	VB16	39,00 €

Zubehör

	SCHRAUBE	UNTERLEGPLATTE	UP-SCHRAUBE
VB16: 1616	M3,5x12 (T15)	BAX VB16 - 9618	SBV5 M5x0,5 A3,5x9 - 9408 (SW3,5)
VB16: 2020, 2525	M3,5x12 (T15)	BAX VB16 - 9618	SBV M5x0,5 A3,5x11 - 9407 (SW3,5)

SVVBN (72,5°) FÜR VB.. - PROFILDREHEN



Art. Nr.		h=H	B	L	f	Platte	
SM04559	SVVBN 2020 K16	20	20	125	10	VB16	39,00 €
SM04603	SVVBN 2525 M16	25	25	150	12,50	VB16	39,00 €

Zubehör

	SCHRAUBE	UNTERLEGPLATTE	UP-SCHRAUBE
	SSV M3,5x14 - 9512 (T15)	BAX VB16 - 9618	SBV5 M5x0,5 A3,5x11 - 9407 (SW3,5)

SVUBR/L (93°) FÜR VB.. - PROFILDREHEN



Art. Nr. R	Art. Nr. L	d	h	L	f	Dmin	Platte		
SM08298	SM08328	S16P SVUBR/L 11	16	15	170	13	≥21	VB11	35,00 €
SM08267	SM08342	S20R SVUBR/L 11	20	18	200	15	≥25	VB11	41,00 €
SM08397	SM08441	S25S SVUBR/L 16	25	23	250	19,5	≥32	VB16	45,00 €
SM08410	SM08472	S32T SVUBR/L 16	32	30	300	24	≥40	VB16	64,00 €
SM08502	SM08519	S40U SVUBR/L 16	40	37	350	30	≥50	VB16	72,00 €

Zubehör

	SCHRAUBE	UNTERLEGPLATTE	UP-SCHRAUBE
S25S	SSV M3,5x10 - 9511 (T15)	BAX VB16 - 9618	SBV5 M5x0,5 A3,5x9 - 9408 (SW3,5)
S32T, S40U	SSV M3,5x14 - 9512 (T15)	BAX VB16 - 9618	SBV M5x0,5 A3,5x11 - 9407 (SW3,5)

SVQBR/L (107,5°) FÜR VB.. - PROFILDREHEN



Art. Nr. R	Art. Nr. L	d	h	L	f	Dmin	Platte		
SM08304	SM08366	S16P SVQBR/L 11	16	15	170	13	≥21	VB11	34,00 €
SM08274	SM08380	S20R SVQBR/L 11	20	18	200	15	≥25	VB11	41,00 €
SM08403	SM08434	S25S SVQBR/L 16	25	23	250	19,5	≥32	VB16	42,00 €
SM08465	SM08458	S32T SVQBR/L 16	32	30	300	24	≥40	VB16	63,00 €

Zubehör

	SCHRAUBE	UNTERLEGPLATTE	UP-SCHRAUBE
S16P	SSV M2,5x6 - 9505 (T08)	---	---
S20R	SSV M2,5x6 - 9505 (T08)	---	---
S25S	SSV M3,5x10 - 9511 (T15)	BAX VB16 - 9618	SBV5 M5x0,5 A3,5x9 - 9408 (SW3,5)
S32T	SSV M3,5x14 - 9512 (T15)	BAX VB16 - 9618	SBV M5x0,5 A3,5x11 - 9407 (SW3,5)

SVJBR/L (93°) FÜR VB.. - PROFILDREHEN



Art. Nr. R	Art. Nr. L	d	h	L	f	Dmin	Platte		
SM49505	SM49499	S25S SVJBR/L 16	25	23	250	19,5	≥32	VB16	42,00 €

Zubehör

	SCHRAUBE	UNTERLEGPLATTE	UP-SCHRAUBE
S25S	SSV M3,5x10 - 9511 (T15)	BAX VB16 - 9618	SBV5 M5x0,5 A3,5x9 - 9408 (SW3,5)

VC..

POSITIVE WENDESCHNEIDPLATTE

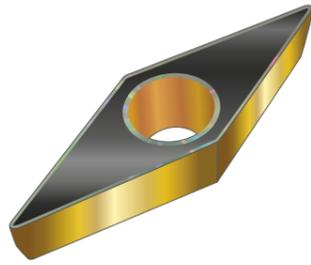
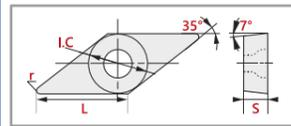

ABMESSUNGEN	r	L	IC	S
VC.. 110302	0,2	11	6,35	3,18
VC.. 110304	0,4	11	6,35	3,18
VC.. 110308	0,8	11	6,35	3,18
VC.. 160401	0,1	16	9,525	4,76
VC.. 160402	0,2	16	9,525	4,76
VC.. 160404	0,4	16	9,525	4,76
VC.. 160408	0,8	16	9,525	4,76
VC.. 160412	1,2	16	9,525	4,76

P VCMT FÜR DIE STAHLBEARBEITUNG

Art. Nr.	Schichten	Preis
1771671	VCMT 110302-PF RT225+	4,90 €
1771672	VCMT 110304-PF RT215+	4,90 €
1771673	VCMT 110308-PF RT215+	4,90 €
1771674	VCMT 160404-PF RT215+	5,70 €
1771675	VCMT 160408-PF RT215+	5,70 €

Art. Nr.	Mittlere Bearbeitung	Preis
1771661	VCMT 160404-PM RT250+	5,70 €

N VCGT FÜR NE-METALLE

Art. Nr.	Preis
1771331	VCGT 110302-ALZ RT100 4,20 €
1771332	VCGT 110304-ALZ RT100 4,20 €
1771333	VCGT 160402-ALZ RT100 4,40 €
1771334	VCGT 160404-ALZ RT100 4,40 €
1771335	VCGT 160408-ALZ RT100 4,40 €
1771336	VCGT 160412-ALZ RT100 4,40 €

M N VCGT FÜR STAHL UND EDELSTAHL

Art. Nr.	Schichten/Mittlere Bearbeitung	Preis
1771351	VCGT 110302-ALM RT105C	4,85 €
1771352	VCGT 110304-ALM RT105C	4,85 €
1771353	VCGT 110308-ALM RT105C	4,85 €
1771354	VCGT 160402-ALM RT105C	5,70 €
1771355	VCGT 160404-ALM RT105C	5,70 €
1771356	VCGT 160408-ALM RT105C	5,70 €

M VCMT FÜR EDELSTAHL

Art. Nr.	Mittlere Bearbeitung	Preis
1771681	VCMT 110304-MF RT255M	5,40 €

H VCGW - CBN FÜR GEHÄRTETEN STAHL

Art. Nr.	CBN 2 Schneiden	Preis
1771486	VCGW 110304-2N RTC20T	29,50 €
1771487	VCGW 110308-2N RTC20T	29,50 €

2 Schneiden

Art. Nr.	CBN 2 Schneiden	Preis
1771491	VCGW 160404-2N RTC20T	29,50 €
1771492	VCGW 160408-2N RTC20T	29,50 €

N VC.. - PKD FÜR HIGH SPEED ALUBEARBEITUNG

Art. Nr.	Flat	Preis
1771521	VCGW 110302-1N RTD10	22,95 €
1771522	VCGW 110304-1N RTD10	22,95 €
1771526	VCGW 160401-1N RTD10	25,90 €
1771523	VCGW 160402-1N RTD10	22,95 €
1771524	VCGW 160404-1N RTD10	22,95 €
1771525	VCGW 160408-1N RTD10	22,95 €

Art. Nr.	mit 7° positivem Spanwinkel	Preis
1771531	VCGT 110302-1N RTD10	22,95 €
1771532	VCGT 110304-1N RTD10	22,95 €
1771533	VCGT 160402-1N RTD10	22,95 €
1771534	VCGT 160404-1N RTD10	22,95 €
1771535	VCGT 160408-1N RTD10	22,95 €



SVJCR/L (93°) FÜR VC.. - PROFILDREHEN

Art. Nr. R	Art. Nr. L	h=H	B	L	f	Platte	Preis	
SM26971	SM26995	SVJCR/L 1616 H11	16	16	100	20	VC11	39,00 €
SM20962	SM27008	SVJCR/L 2020 K11	20	20	125	25	VC11	39,00 €
SM23611	SM23635	SVJCR/L 2020 K16	20	20	125	25	VC16	39,00 €
SM23604	SM23628	SVJCR/L 2525 M16	25	25	150	30	VC16	39,00 €

Zubehör

	SCHRAUBE	UNTERLEGPLATTE	UP-SCHRAUBE
VC11	SSV M2,5x6 -9505 (T08)	---	---
VC16	SSV M3,5x14 - 9512 (T15)	BAX VC16 - 9620	SBV M5x0,5 A3,5x11 - 9407 (SW3,5)



SVVCN (72,5°) FÜR VC.. - PROFILDREHEN

Art. Nr.	h=H	B	L	f	Platte	Preis	
SM44401	SVVCN 2020 K16	20	20	125	10	VC16	39,00 €
SM40199	SVVCN 2525 M16	25	25	150	12,50	VC16	39,00 €

Zubehör

	SCHRAUBE	UNTERLEGPLATTE	UP-SCHRAUBE
VC16	M3,5x12 (T15)	BAX VC16 - 9620	SBV M5x0,5 A3,5x11 - 9407 (SW3,5)



SVUCR/L (93°) FÜR VC.. - PROFILDREHEN

Art. Nr. R	Art. Nr. L	d	h	L	f	Dmin	Platte	Preis	
SM08373	SM08632	S16P SVUCR/L 11	32	30	300	24	≥40	VC11	35,00 €
SM08656	SM08663	S20R SVUCR/L 11	40	37	350	30	≥50	VC11	41,00 €
SM08717	SM08724	S25S SVUCR/L 16	25	23	250	19,5	≥32	VC16	45,00 €
SM08731	SM08748	S32T SVUCR/L 16	32	30	300	24	≥40	VC16	64,00 €
SM08755	SM08762	S40U SVUCR/L 16	40	37	350	30	≥50	VC16	72,00 €

Zubehör

	SCHRAUBE	UNTERLEGPLATTE	UP-SCHRAUBE
VC11	SSV M2,5x6 -9505 (T08)	---	---
VC16: S25S	SSV M3,5x10 - 9511 (T15)	BAX VC16 - 9620	SBV5 M5x0,5 A3,5x9 - 9408 (SW3,5)
VC16: S32T, S40U	SSV M3,5x14 -9512 (T15)	BAX VC16 - 9620	SBV M5x0,5 A3,5x11 - 9407 (SW3,5)

TC..

POSITIVE WENDESCHNEIDPLATTE

ABMESSUNGEN

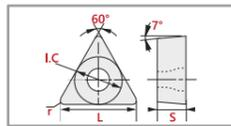
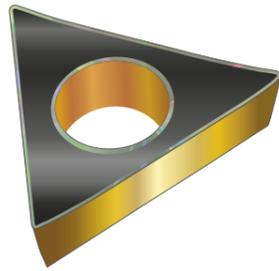

	r	L	IC	S
TC.. 110202	0,2	11	6,35	2,38
TC.. 110204	0,4	11	6,35	2,38
TC.. 110208	0,8	11	6,35	2,38
TC.. 16T302	0,2	16,5	9,525	4,4
TC.. 16T304	0,4	16,5	9,525	4,4
TC.. 16T308	0,8	16,5	9,525	4,4

P TCMT FÜR DIE STAHLBEARBEITUNG

Art. Nr.	Mittlere Bearbeitung	Preis
1771611	TCMT 110204-PM RT250+	3,20 €
1771612	TCMT 16T304-PM RT250+	3,90 €
1771613	TCMT 16T308-PM RT250+	3,90 €

M N TCGT FÜR EDELSTAHL UND NE-METALLE

Art. Nr.	Schlichten/Mittlere Bearbeitung	Preis
1771411	TCGT 110202-ALM RT105C	4,70 €
1771412	TCGT 110204-ALM RT105C	4,70 €
1771413	TCGT 16T304-ALM RT105C	5,20 €
1771414	TCGT 16T308-ALM RT105C	5,20 €

P M TCMT FÜR STAHL UND EDELSTAHL

Art. Nr.	Mittlere Bearbeitung	Preis
1771252	TCMT 110202-HM RT300	3,20 €
1771253	TCMT 110204-HM RT300	3,20 €
1771254	TCMT 16T304-HM RT300	3,90 €
1771255	TCMT 16T308-HM RT300	3,90 €

N TCGT FÜR NE-METALLE

Art. Nr.	Preis
1771211	TCGT 110202-ALZ RT100 3,00 €
1771212	TCGT 110204-ALZ RT100 3,00 €
1771213	TCGT 110208-ALZ RT100 3,00 €
1771214	TCGT 16T302-ALZ RT100 3,50 €
1771215	TCGT 16T304-ALZ RT100 3,50 €
1771216	TCGT 16T308-ALZ RT100 3,50 €

STGCR/L (90°) FÜR TC.. - LÄNGSDREHEN

Art. Nr. R	Art. Nr. L	h=H	B	L	f	Platte	Preis
SM03910	SM03941	12	12	80	15	TC11	29,00 €
SM03972	SM03989	16	16	100	20	TC11	34,00 €
SM04092	SM04108	16	16	100	20	TC16	34,00 €
SM04139	SM04146	20	20	125	25	TC16	36,00 €

Zubehör

SCHRAUBE	UNTERLEGPLATTE	UP-SCHRAUBE
TC11	SSV M2,5x6 -9505 (T08)	---
TC16	M3,5x12 (T15)	---

STNCN FÜR TC.. - PLANDREHEN

Art. Nr.	h=H	B	L	f	l	Platte	Preis
SM44432	20	20	125	10	25	TC11	40,00 €
SM44425	20	20	125	10	30	TC16	40,00 €
SM45095	25	25	150	12,5	35	TC16	41,00 €

Zubehör

SCHRAUBE	UNTERLEGPLATTE	UP-SCHRAUBE
TC11	SSV M2,5x6 -9505 (T08)	---
TC16	SSV M3,5x14 - 9512 (T15)	BAX TC16 - 9619 SBV5 M5x0,5 A3,5x11 - 9407 (SW3,5)

STFCR/L (90°) FÜR TC.. - INNENAUSDREHEN

Art. Nr. R	Art. Nr. L	d	h	L	f	Dmin	Platte	Preis
SM07819	SM07796	10	9	125	10	≥13	TC11	22,00 €
SM07826	SM07833	12	11	125	10	≥17	TC11	24,00 €
SM07864	SM07871	16	15	170	13	≥21	TC11	32,00 €

Zubehör

SCHRAUBE	UNTERLEGPLATTE	UP-SCHRAUBE
TC11	SSV M2,5x5 -9504 (T08)	---

HARTMETALL-INNENDREHHALTER

Werkzeugträger aus Vollhartmetall erhöhen die Stabilität erheblich. Die Hartmetallbohrstange erlaubt durch Reduzierung der Vibrationen eine Ausraglänge von bis zu 6xD. Präzision und Oberflächenqualität werden ebenfalls verbessert.

HARTMETALL-INNENDREHHALTER E-SCLCR/L (95°) FÜR CC..



INNENAUSDREHEN/PLANDREHEN

Alle VHM-Bohrstangen mit innerer Kühlmittelzufuhr.

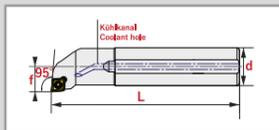

Art. Nr. R	Art. Nr. L	d	L	f	Dmin	Platte	Preis
SM60074	SM60135	08	125	06	≥13	CC06	90,00 €
SM60081	SM60142	10	150	08	≥16	CC06	129,00 €
SM60098	SM60159	12	180	10	≥21	CC06	185,00 €
SM60111	SM60173	16	200	13	≥21	CC09	217,00 €

Zubehör

SCHRAUBE	UNTERLEGPLATTE	UP-SCHRAUBE
E08K	SSV M2,5x5 -9504 (T08)	---
E10M, E12Q	SSV M2,5x6 -9505 (T08)	---
E16R	SSV M3,5x8 -9510 (T15)	---

HARTMETALL-INNENDREHHALTER E-SDQCR/L (107,5°) FÜR DC..



PROFILDREHEN

Alle VHM-Bohrstangen mit innerer Kühlmittelzufuhr.

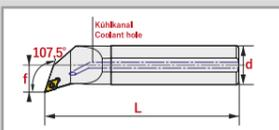

Art. Nr. R	Art. Nr. L	d	L	f	Dmin	Platte	Preis
SM59979	SM60012	10	150	08	≥13	DC07	129,00 €
SM59986	SM60029	12	180	10	≥16	DC07	185,00 €
SM59993	SM60036	16	200	13	≥21	DC11	217,00 €

Zubehör

SCHRAUBE	UNTERLEGPLATTE	UP-SCHRAUBE
E10M, E12Q	SSV M2,5x6 -9505 (T08)	---
E16R	SSV M3,5x10 -9511 (T15)	---

HARTMETALL-INNENDREHHALTER E-SDUCR/L (93°) FÜR DC..



PROFILDREHEN

Alle VHM-Bohrstangen mit innerer Kühlmittelzufuhr.

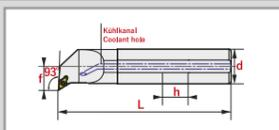

Art. Nr. R	Art. Nr. L	d	L	f	Dmin	Platte	Preis
SM59771	SM59818	10	150	08	≥13	DC07	129,00 €
SM59788	SM59825	12	180	10	≥16	DC07	185,00 €
SM59795	SM59832	16	200	13	≥21	DC11	217,00 €

Zubehör

SCHRAUBE	UNTERLEGPLATTE	UP-SCHRAUBE
E10M, E12Q	SSV M2,5x6 -9505 (T08)	---
E16R	SSV M3,5x10 -9511 (T15)	---



TC..

CBN-WENDESCHNEIDPLATTEN

TIN-BESCHICHTETE CBN-SORTE FÜR DIE BEARBEITUNG VON GEHÄRTETEM STAHL
IM GLATTEN SOWIE IM LEICHT UNTERBROCHENEN SCHNITT

H CNGA... FÜR GEHÄRTETEN STAHL



2 Schneiden

Art. Nr.	r	L	I.C.	S	d	
1661591 CNGA 120404-2N RTC20T	0,4	2,2	12,7	4,76	5,16	29,50 €
1661592 CNGA 120408-2N RTC20T	0,8	2,2	12,7	4,76	5,16	29,50 €

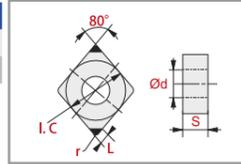

H DNGA... FÜR GEHÄRTETEN STAHL



2 Schneiden

Art. Nr.	r	L	I.C.	S	d	
1661596 DNGA 150604-2N RTC20T	0,4	2,2	12,7	6,35	5,16	29,50 €
1661597 DNGA 150608-2N RTC20T	0,8	2,2	12,7	6,35	5,16	29,50 €

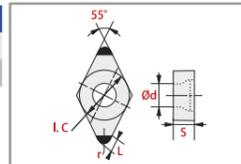

H WNGA... FÜR GEHÄRTETEN STAHL



3 Schneiden

Art. Nr.	r	L	I.C.	S	d	
1661601 WNGA 080404-3N RTC20T	0,4	2,2	12,7	4,76	5,16	36,90 €
1661602 WNGA 080408-3N RTC20T	0,8	2,2	12,7	4,76	5,16	36,90 €

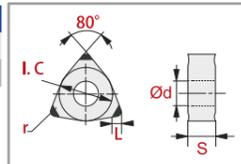

H CCGW... FÜR GEHÄRTETEN STAHL



2 Schneiden

Art. Nr.	r	L	I.C.	S	d	
1771461 CCGW 060202-2N RTC20T	0,2	2,2	6,35	2,38	2,8	29,50 €
1771462 CCGW 060204-2N RTC20T	0,4	2,2	6,35	2,38	2,8	29,50 €
1771463 CCGW 060208-2N RTC20T	0,8	2,2	6,35	2,38	2,8	29,50 €

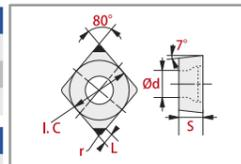

Art. Nr.	r	L	I.C.	S	d	
1771471 CCGW 09T302-2N RTC20T	0,2	2,2	9,525	3,97	4,4	29,50 €
1771472 CCGW 09T304-2N RTC20T	0,4	2,2	9,525	3,97	4,4	29,50 €
1771473 CCGW 09T308-2N RTC20T	0,8	2,2	9,525	3,97	4,4	29,50 €
1771474 CCGW 09T312-2N RTC20T	1,2	2,2	9,525	3,97	4,4	29,50 €

Art. Nr.	r	L	I.C.	S	d	
1771470 CCGW 120404-2N RTC20T	0,4	2,2	6,35	2,38	2,8	29,50 €
1771475 CCGW 120408-2N RTC20T	0,8	2,2	6,35	2,38	2,8	29,50 €

H DCGW... FÜR GEHÄRTETEN STAHL



2 Schneiden

Art. Nr.	r	L	I.C.	S	d	
1771476 DCGW 070204-2N RTC20T	0,4	2,2	6,35	2,38	2,8	29,50 €
1771477 DCGW 070208-2N RTC20T	0,8	2,2	6,35	2,38	2,8	29,50 €

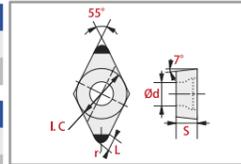

Art. Nr.	r	L	I.C.	S	d	
1771481 DCGW 11T302-2N RTC20T	0,2	2,2	9,525	3,97	4,4	29,50 €
1771482 DCGW 11T304-2N RTC20T	0,4	2,2	9,525	3,97	4,4	29,50 €
1771483 DCGW 11T308-2N RTC20T	0,8	2,2	9,525	3,97	4,4	29,50 €

H VBGW... FÜR GEHÄRTETEN STAHL



2 Schneiden

Art. Nr.	r	L	I.C.	S	d	
1771501 VBGW 160402-2N RTC20T	0,2	2,2	9,525	4,76	4,4	29,50 €
1771502 VBGW 160404-2N RTC20T	0,4	2,2	9,525	4,76	4,4	29,50 €
1771503 VBGW 160408-2N RTC20T	0,8	2,2	9,525	4,76	4,4	29,50 €

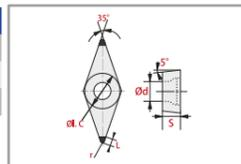

H VCGW... FÜR GEHÄRTETEN STAHL



2 Schneiden

Art. Nr.	r	L	I.C.	S	d	
1771486 VCGW 110304-2N RTC20T	0,4	2,2	6,35	3,18	2,8	29,50 €
1771487 VCGW 110308-2N RTC20T	0,8	2,2	6,35	3,18	2,8	29,50 €

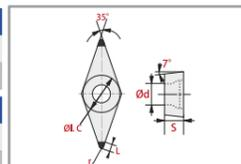

Art. Nr.	r	L	I.C.	S	d	
1771491 VCGW 160404-2N RTC20T	0,4	2,2	9,525	4,76	4,4	29,50 €
1771492 VCGW 160408-2N RTC20T	0,8	2,2	9,525	4,76	4,4	29,50 €

NEU! PKD-WENDESCHNEIDPLATTEN

PKD = POLYKRISTALLINER DIAMANT (PKD, ENGL. PCD) IST EINE SYNTHETISCH HERGESTELLTE, EXTREM HARTE, UNTEREINANDER VERWACHSENE MASSE VON DIAMANTPARTIKELN MIT ZUFALLSORIENTIERUNG IN EINER METALLMATRIX.

N C-CCGW... MIT SPANFORMER



Art. Nr.	r	L	I.C.	S	d	
1771586 C-CCGW 060202-1N RTD10	0,2	2,5	6,35	2,38	2,8	31,90 €
1771587 C-CCGW 09T304-1N RTD10	0,4	2,5	9,525	3,97	4,4	31,90 €

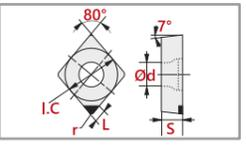

N CCGT... MIT 7° POSITIVEM SPANWINKEL

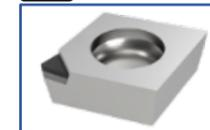

Art. Nr.	r	L	I.C.	S	d	
1771591 CCGT 060202-1N RTD10	0,2	2,5	6,35	2,38	2,8	22,95 €
1771592 CCGT 060204-1N RTD10	0,4	2,5	6,35	2,38	2,8	22,95 €
1771593 CCGT 09T302-1N RTD10	0,2	2,5	9,525	3,97	4,4	22,95 €
1771594 CCGT 09T304-1N RTD10	0,4	2,5	9,525	3,97	4,4	22,95 €
1771595 CCGT 09T308-1N RTD10	0,8	2,5	9,525	3,97	4,4	22,95 €

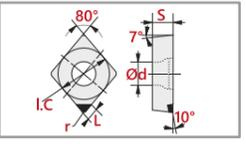

N CCGW... FLAT



Art. Nr.	r	L	I.C.	S	d	
1771581 CCGW 060202-1N RTD10	0,2	2,5	6,35	2,38	2,8	22,95 €
1771582 CCGW 060204-1N RTD10	0,4	2,5	6,35	2,38	2,8	22,95 €
1771583 CCGW 09T302-1N RTD10	0,2	2,5	9,525	3,97	4,4	22,95 €
1771584 CCGW 09T304-1N RTD10	0,4	2,5	9,525	3,97	4,4	22,95 €
1771585 CCGW 09T308-1N RTD10	0,8	2,5	9,525	3,97	4,4	22,95 €

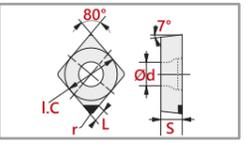

N DCGT... MIT 7° POSITIVEM SPANWINKEL



Art. Nr.	r	L	I.C.	S	d	
1771571 DCGT 070202-1N RTD10	0,2	2,5	6,35	2,38	2,8	22,95 €
1771572 DCGT 070204-1N RTD10	0,4	2,5	6,35	2,38	2,8	22,95 €
1771573 DCGT 11T302-1N RTD10	0,2	2,5	9,525	3,97	4,4	22,95 €
1771574 DCGT 11T304-1N RTD10	0,4	2,5	9,525	3,97	4,4	22,95 €
1771575 DCGT 11T308-1N RTD10	0,8	2,5	9,525	3,97	4,4	22,95 €

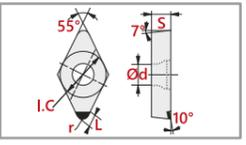

N DCGW... FLAT



Art. Nr.	r	L	I.C.	S	d	
1771561 DCGW 070202-1N RTD10	0,2	2,5	6,35	2,38	2,8	22,95 €
1771562 DCGW 070204-1N RTD10	0,4	2,5	6,35	2,38	2,8	22,95 €
1771563 DCGW 11T302-1N RTD10	0,2	2,5	9,525	3,97	4,4	22,95 €
1771564 DCGW 11T304-1N RTD10	0,4	2,5	9,525	3,97	4,4	22,95 €
1771565 DCGW 11T308-1N RTD10	0,8	2,5	9,525	3,97	4,4	22,95 €

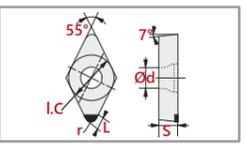

N VBGT... MIT 7° POSITIVEM SPANWINKEL



Art. Nr.	r	L	I.C.	S	d	
1771551 VBGT 160402-1N RTD10	0,2	2,5	9,525	4,76	4,4	22,95 €
1771552 VBGT 160404-1N RTD10	0,4	2,5	9,525	4,76	4,4	22,95 €
1771553 VBGT 160408-1N RTD10	0,8	2,5	9,525	4,76	4,4	22,95 €

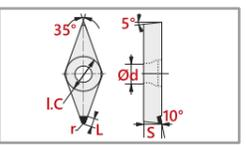

N VBGW... FLAT



Art. Nr.	r	L	I.C.	S	d	
1771541 VBGW 160402-1N RTD10	0,2	2,5	9,525	4,76	4,4	22,95 €
1771542 VBGW 160404-1N RTD10	0,4	2,5	9,525	4,76	4,4	22,95 €
1771543 VBGW 160408-1N RTD10	0,8	2,5	9,525	4,76	4,4	22,95 €

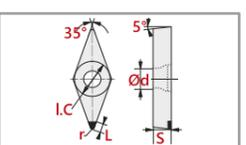

N VCGT... MIT 7° POSITIVEM SPANWINKEL



Art. Nr.	r	L	I.C.	S	d	
1771531 VCGT 110302-1N RTD10	0,2	2,5	6,35	3,18	2,8	22,95 €
1771532 VCGT 110304-1N RTD10	0,4	2,5	6,35	3,18	2,8	22,95 €
1771533 VCGT 160402-1N RTD10	0,2	2,5	9,525	4,76	4,4	22,95 €
1771534 VCGT 160404-1N RTD10	0,4	2,5	9,525	4,76	4,4	22,95 €
1771535 VCGT 160408-1N RTD10	0,8	2,5	9,525	4,76	4,4	22,95 €

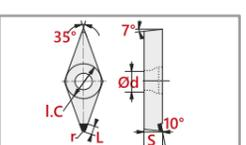

N VCGW... FLAT



Art. Nr.	r	L	I.C.	S	d	
1771521 VCGW 110302-1N RTD10	0,2	2,5	6,35	3,18	2,8	22,95 €
1771522 VCGW 110304-1N RTD10	0,4	2,5	6,35	3,18	2,8	22,95 €
1771526 VCGW 160401-1N RTD10	0,1	2,5	9,525	4,76	4,4	25,90 €
1771523 VCGW 160402-1N RTD10	0,2	2,5	9,525	4,76	4,4	22,95 €
1771524 VCGW 160404-1N RTD10	0,4	2,5	9,525	4,76	4,4	22,95 €
1771525 VCGW 160408-1N RTD10	0,8	2,5	9,525	4,76	4,4	22,95 €

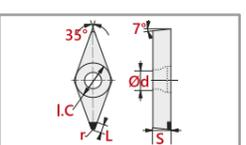

ZA-STECHSCHWERT-SYSTEM

P M ZA 0302-MG.. RT250X

- IN DEN AUSFÜHRUNGEN NEUTRAL ODER MIT ABSTECHSCHRÄGE 6° R ODER L LIEFERBAR
- 3 MM STECHBREITE
- EINSCHNEIDER FÜR MAXIMALE STECHTIEFE



Art. Nr.		L	R	W	f	
1331022	ZA 0302-MG RT250X	19,9	0,2	3	0,04-0,10	6,90 €
1331023	ZA 0302-MG-6L RT250X	19,9	0,2	3	0,04-0,10	7,40 €
1331024	ZA 0302-MG-6R RT250X	19,9	0,2	3	0,04-0,10	7,40 €

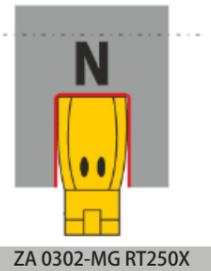
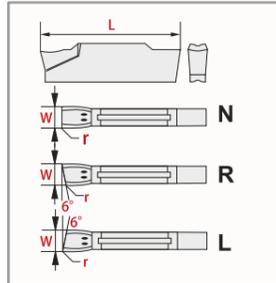

ZA 0302-MG RT250X

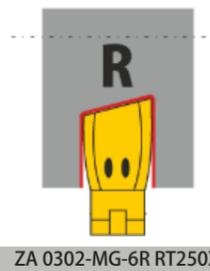

ZA 0302-MG-6R RT250X

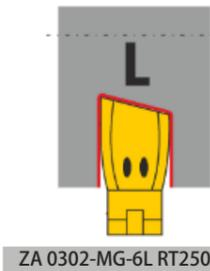

ZA 0302-MG-6L RT250X

ZA-SYSTEM-SCHWERT



Art. Nr.		Stechb.	H	H1	A	L	
SM61453	SML 26-ZT-3C	3	26	21,4	1,6	110	53,00 €
SM54851	SML 32-ZT-3C	3	32	25	2,4	150	55,00 €

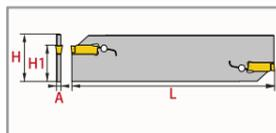

GTN-STECHSCHWERT-SYSTEM

P M GTN RT300



Art. Nr.		W	r	Anwendungsbereich	
1331081	GTN-2 RT300	2,20	0,20	STAHL & EDELSTAHL	3,90 €
1331082	GTN-3 RT300	3,10	0,20	STAHL & EDELSTAHL	4,20 €
1331083	GTN-4 RT300	4,10	0,20	STAHL & EDELSTAHL	4,50 €
1331084	GTN-5 RT300	5,10	0,20	STAHL & EDELSTAHL	4,90 €

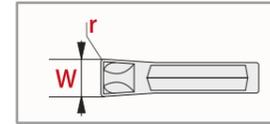

N GTN RT100



Art. Nr.		W	r	Anwendungsbereich	
1331331	GTN-2 RT100	2,20	0,20	NE-METALLE	7,30 €
1331332	GTN-3 RT100	3,10	0,20	NE-METALLE	7,30 €
1331333	GTN-4 RT100	4,10	0,25	NE-METALLE	7,70 €
1331334	GTN-5 RT100	5,10	0,20	NE-METALLE	8,20 €

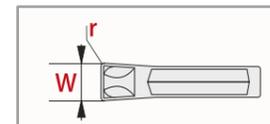

GTN-SYSTEM-SCHWERT



Art. Nr.		S.Breite	H	W	L	h	Platte	
1331101	GTN SCHWERT 26-2	2	26	1,6	110	21	GTN-2	36,00 €
1331105	GTN SCHWERT 32-2	2	26	1,6	110	21	GTN-2	36,00 €
1331102	GTN SCHWERT 26-3	3	26	2,4	110	21	GTN-3	36,00 €
1331103	GTN SCHWERT 32-3	3	32	2,4	150	25	GTN-3	36,00 €
1331104	GTN SCHWERT 32-4	4	32	3,2	150	25	GTN-4	36,00 €
1331106	GTN SCHWERT 32-5	5	32	4,0	150	25	GTN-5	36,00 €

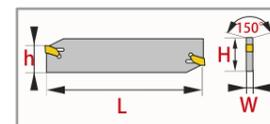

SPANNBLOCK

FÜR ALLE GÄNGIGEN STECHSCHWERTER

Art. Nr.		H	H1	H2	H3	H4	W1	W2	B	L	
SM54875	SMLK 20-26	20	43	9	26	21,4	4	38	19	86	73,00 €
SM54899	SMLK 25-26	25	45	5	26	21,4	4	42	23	110	81,00 €
SM54882	SMLK 20-32	20	50	13	32	25	5,3	38	19	100	73,00 €
SM54905	SMLK 25-32	25	50	8	32	25	5,3	42	23	110	81,00 €
SM54912	SMLK 32-32	32	54	5	32	25	5,3	38	29	110	81,00 €

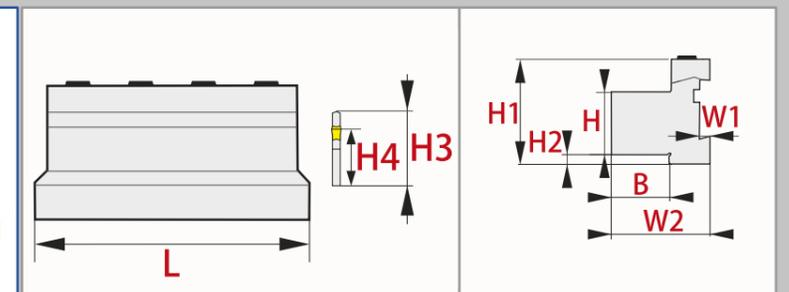

MG../MR..-STECHSYSTEM

MG../MR.. STECHPLATTEN



MGMN-M RT300 - STAHL & EDELSTAHL - EINSTECHEN

P
M

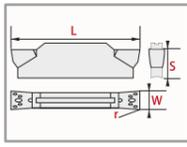

Art. Nr.	W	R	L	S	
1331143 MGMN 200-M RT300	2	0,2	16	3,5	7,50 €
1331140 MGMN 300-M RT300	3	0,4	21	4,8	7,50 €
1331141 MGMN 400-M RT300	4	0,4	21	4,8	8,50 €
1331142 MGMN 500-M RT300	5	0,8	26	5,8	9,90 €



MRMN-M RT300 - STAHL & EDELSTAHL-VOLLRADIUS - EINSTECHEN

P
M

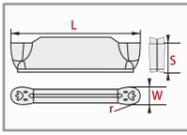

Art. Nr.	W	R	L	S	
1331151 MRMN 200-M RT300	2	1	16	3,5	7,50 €
1331152 MRMN 300-M RT300	3	1,5	21	4,8	7,50 €
1331153 MRMN 400-M RT300	4	2	21	4,8	8,50 €
1331154 MRMN 500-M RT300	5	2,5	25,85	5,8	9,90 €



MGMN-GT RT300 - STAHL & EDELSTAHL - EINSTECHEN UND STECHDREHEN

P
M

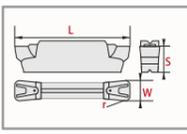

Art. Nr.	W	R	L	S	
1331191 MGMN 300-GT RT300	3	0,4	21	4,8	7,50 €
1331192 MGMN 400-GT RT300	4	0,4	21	4,8	8,50 €



MGMN-J RT300 - STAHL & EDELSTAHL - EIN- UND ABSTECHEN

P
M

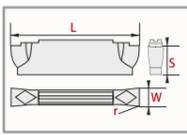

Art. Nr.	W	R	L	S	
1331125 MGMN 200-J RT300	2	0,2	16	3,5	7,50 €
1331126 MGMN 300-J RT300	3	0,2	21	4,8	7,50 €
1331127 MGMN 400-J RT300	4	0,3	21	4,8	8,50 €
1331129 MGMN 500-J RT300	5	0,3	26	4,8	9,90 €



MGMR-J-6D RT300 - STAHL & EDELSTAHL - ABSTECHEN

P
M

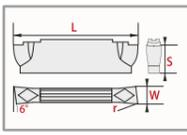

Art. Nr.	W	R	L	S	
1331135 MGMR 200-J-6D RT300*	2	0,2	16	3,5	7,50 €
1331128 MGMR 300-J-6D RT300*	3	0,2	21	4,8	7,50 €

*Absteichschräge 6°



MGMN-C RT300 - STAHL & GUSS - EINSTECHEN

P
K

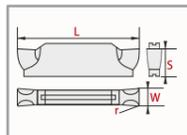

Art. Nr.	W	R	L	S	
1331123 MGMN 200-C RT300	2	0,2	16	3,5	7,50 €
1331124 MGMN 300-C RT300	3	0,4	21	4,9	7,50 €
1331133 MGMN 400-C RT300	4	0,4	21	4,9	8,50 €
1331134 MGMN 500-C RT300	5	0,4	26	5,8	9,90 €



MGMN-AL RT100 - NE-METALLE - EIN- UND ABSTECHEN

N

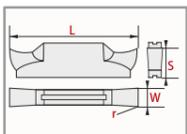

Art. Nr.	W	R	L	S	
1331121 MGMN 200-AL RT100	2	0,2	16	3,5	7,50 €
1331122 MGMN 300-AL RT100	3	0,4	21	4,8	7,50 €
1331131 MGMN 400-AL RT100	4	0,4	21	4,8	8,50 €
1331132 MGMN 500-AL RT100	5	0,8	26	5,8	9,90 €



MGMN-CBN RTC20 - HARTE WERKSTOFFE - EIN- UND ABSTECHEN

H

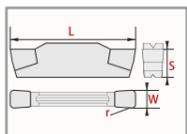

Art. Nr.	W	R	L	S	
1331158 MGMN 200-CBN RTC20	2	0,2	16	4,8	33,00 €
1331159 MGMN 300-CBN RTC20	3	0,4	21	4,8	33,00 €

P Stahl **M** Edelstahl **K** Guss **S** Sonderwerkstoffe **H** Harte Werkstoffe **N** NE-Metalle
 Komplette Träger-Zubehörliste mit Art. Nr. und Preise auf Seite 81.



Abbildung zeigt R

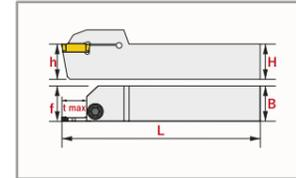

AUSSENSTECHHALTER BDKTR/L FÜR MG../MR..

Art.Nr. R	Art.Nr. L	H=h=B	L	S	t max	W		
SM09493	SM09691	BDKTR/L 1212-K2C	12	100	12,3	15	2	49,00 €
SM09479	SM09660	BDKTR/L 1616-K2C	16	125	16,3	18	2	55,00 €
SM09455	SM09653	BDKTR/L 2020-K2C	20	125	20,3	18	2	55,00 €
SM09462	SM09677	BDKTR/L 2525-K2C	25	150	25,3	18	2	55,00 €
SM09547	SM09745	BDKTR/L 1212-K3C	12	100	12,3	18	3	49,00 €
SM09523	SM09714	BDKTR/L 1616-K3C	16	125	16,4	18	3	55,00 €
SM09509	SM09707	BDKTR/L 2020-K3C	20	125	20,4	20	3	55,00 €
SM09516	SM09721	BDKTR/L 2525-K3C	25	150	25,4	22	3	55,00 €
SM09554	SM09752	BDKTR/L 2020-K4C	20	125	20,4	20	4	55,00 €
SM09561	SM09769	BDKTR/L 2525-K4C	25	150	20,4	22	4	55,00 €
SM09585	SM09783	BDKTR/L 2020-K5C	20	125	20,5	20	5	55,00 €
SM09592	SM09790	BDKTR/L 2525-K5C	25	150	25,5	25	5	55,00 €
SM09608	SM09806	BDKTR/L 3232-K5C	32	170	32,5	25	5	66,00 €

Zubehör

	SCHRAUBE
2MM 1212	BKTV M5x17-9211
2MM 1616/2020/2525	BKTV M6x25-9215
3MM 1212	BKTV M5x17-9211
3MM 1616	BKTV M6x25-9215
3MM 2020/2525	BKTV M8x1x25-9232
4MM / 5 MM	BKTV M8x1x25-9232



Abbildung zeigt R

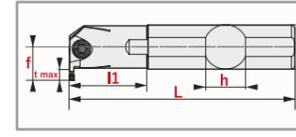

INNENSTECHHALTER BIKTR/L FÜR MG../MR..

Art.Nr. R	Art.Nr. L	d	L	l	h	f	t max	d min	W		
SM11151	SM11298	BIKTR/L 16-K2C	16	150	33	15	11,5	4	20	2	49,00 €
SM11168	SM11304	BIKTR/L 20-K2C	20	170	33	18	14,5	6	26	2	52,00 €
SM11199	SM11335	BIKTR/L 20-K3C	20	170	33	18	15	6	26	3	52,00 €
SM11205	SM11342	BIKTR/L 25-K3C	25	200	45	23	18,5	7	32	3	56,00 €
SM11182	SM11359	BIKTR/L 32-K3C	32	250	49	30	22	8	40	3	59,00 €
SM11236	SM11373	BIKTR/L 25-K4C	25	200	45	23	18,5	7	32	4	56,00 €
SM11243	SM11380	BIKTR/L 32-K4C	32	250	49	30	22	8	40	4	59,00 €

Zubehör

	SCHRAUBE
2 MM, 16	BKTV M4x15-9210
2 MM, 20	BKTV M5x17-9211
3 MM, 20	BKTV M5x17-9211
3 MM, 25	BKTV M6x22-9214
3 MM, 32	BKTV M6x25-9215
4 MM, 25	BKTV M6x22-9214
4 MM, 32	BKTV M6x25-9215

NEU!

INNENSTECHHALTER BEKTR/L FÜR MG../MR.. MIT KÜHLKANÄLE UND T MAX: 10 MM

Art.Nr. R	Art.Nr. L	d	L	l	h	f	t max	d min	W		
SM59597	SM59641	BEKTR/L 25-K3C T MAX:10-IJ	* 25	200	45	23	18,5	10	32	3	68,00 €
SM59610	SM59665	BEKTR/L 32-K3C T MAX:10-IJ	* 32	250	55	30	22	10	40	3	84,00 €
SM59627	SM59672	BEKTR/L 25-K4C T MAX:10-IJ	* 25	200	45	23	18,5	10	32	4	68,00 €
SM59634	SM59689	BEKTR/L 32-K4C T MAX:10-IJ	* 32	250	55	30	22	10	40	4	84,00 €

* = mit Kühlkanal



Abbildung zeigt R

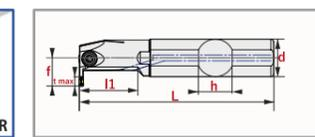

Zubehör

	SCHRAUBE
3 MM, 25	BKTV M6x22-9214
3 MM, 32	BKTV M6x25-9215
4 MM, 25	BKTV M6x22-9214
4 MM, 32	BKTV M6x25-9215



Abbildung zeigt R

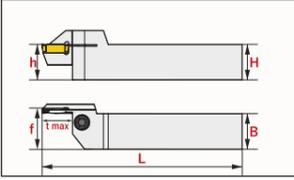

AXIAL-STECHHALTER BDKT-A FÜR MGMN/MRMN

Art.Nr.	H=h=B	L	S	t max	d min	d max	W		
SM10543	BDKT-A 2525-K3C (Ø24-36)	25	150	26,5	17	24	36	3	82,00 €
SM10567	BDKT-A 2525-K3C (Ø36-48)	25	150	26,5	17	36	48	3	82,00 €
SM10550	BDKT-A 2525-K3C (Ø48-70)	25	150	26,5	17	48	70	3	82,00 €
SM10536	BDKT-A 2525-K3C (Ø70-110)	25	150	26,5	17	70	110	3	82,00 €
SM10512	BDKT-A 2525-K3C (Ø100-150)	25	150	26,5	17	100	150	3	82,00 €
SM10529	BDKT-A 2525-K3C (Ø150-200)	25	150	26,5	17	150	200	3	82,00 €
SM39643	BDKT-A 2525-K3C (Ø200-350)	25	150	26,5	17	200	350	3	82,00 €
SM39650	BDKT-A 2525-K3C (Ø300-500)	25	150	26,5	17	300	500	3	82,00 €
SM10581	BDKT-A 2525-K4C (Ø24-36)	25	150	26,5	22	24	36	4	82,00 €
SM10604	BDKT-A 2525-K4C (Ø36-48)	25	150	26,5	22	36	48	4	82,00 €
SM10598	BDKT-A 2525-K4C (Ø48-70)	25	150	26,5	22	48	70	4	82,00 €
SM10574	BDKT-A 2525-K4C (Ø70-110)	25	150	26,5	22	70	110	4	82,00 €
SM10628	BDKT-A 2525-K4C (Ø100-150)	25	150	26,5	22	100	150	4	82,00 €
SM10611	BDKT-A 2525-K4C (Ø150-200)	25	150	26,5	22	150	200	4	82,00 €
SM39667	BDKT-A 2525-K4C (Ø200-350)	25	150	26,5	22	200	350	4	82,00 €
SM39674	BDKT-A 2525-K4C (Ø300-500)	25	150	26,5	22	300	500	4	82,00 €

Zubehör



SCHRAUBE
BKT M8x1x25-9232



Abbildung zeigt R

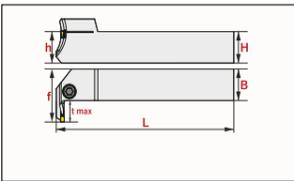

AXIAL-STECHHALTER BDKT-LT FÜR MGMN/MRMN

Art.Nr.	H=h=B	L	S	t max	d min	d max	W		
SM37854	BDKT-LT 2525-K3C (Ø24-36)	25	150	26,5	17	24	36	3	82,00 €
SM34624	BDKT-LT 2525-K3C (Ø36-48)	25	150	26,5	17	36	48	3	82,00 €
SM34631	BDKT-LT 2525-K3C (Ø48-70)	25	150	26,5	17	48	70	3	82,00 €
SM34648	BDKT-LT 2525-K3C (Ø70-110)	25	150	26,5	17	70	110	3	82,00 €
SM34655	BDKT-LT 2525-K3C (Ø100-150)	25	150	26,5	17	100	150	3	82,00 €
SM34662	BDKT-LT 2525-K3C (Ø150-200)	25	150	26,5	17	150	200	3	82,00 €
SM39766	BDKT-LT 2525-K3C (Ø200-350)	25	150	26,5	17	200	350	3	82,00 €
SM39773	BDKT-LT 2525-K3C (Ø300-500)	25	150	26,5	17	300	500	3	82,00 €
SM37861	BDKT-LT 2525-K4C (Ø36-48)	25	150	26,5	20	36	48	4	82,00 €
SM37878	BDKT-LT 2525-K4C (Ø48-70)	25	150	26,5	20	48	70	4	82,00 €
SM34679	BDKT-LT 2525-K4C (Ø70-110)	25	150	26,5	20	70	110	4	82,00 €
SM34686	BDKT-LT 2525-K4C (Ø100-150)	25	150	26,5	20	100	150	4	82,00 €
SM34693	BDKT-LT 2525-K4C (Ø150-200)	25	150	26,5	20	150	200	4	82,00 €
SM39780	BDKT-LT 2525-K4C (Ø200-350)	25	150	26,5	20	200	350	4	82,00 €
SM39797	BDKT-LT 2525-K4C (Ø300-500)	25	150	26,5	20	300	500	4	82,00 €

Zubehör



SCHRAUBE
BKT M8x1x25-9232

RT16-STECHSYSTEM

P M RT16R/L... RT305 - SCHMALE EINSTICHE - SEEGERRING NUTEN

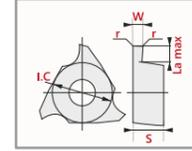
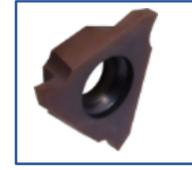

Art. Nr. R	Art. Nr. L	W±0,025	r	La max	Ø.I.C	S		
1331161	1331176	RT16R/L075-R01 RT305	0,75	0,1	2	9,525	3,18	9,80 €
1331162	1331177	RT16R/L095-R01 RT305	0,95	0,1	2	9,525	3,18	9,80 €
1331163	1331178	RT16R/L100-R01 RT305	1,0	0,1	2	9,525	3,18	9,80 €
1331164	1331179	RT16R/L110-R01 RT305	1,1	0,1	2	9,525	3,18	9,80 €
1331165	1331180	RT16R/L120-R01 RT305	1,2	0,1	2	9,525	3,18	9,80 €
1331166	1331181	RT16R/L125-R02 RT305	1,25	0,2	2	9,525	3,18	9,80 €
1331167	1331182	RT16R/L130-R02 RT305	1,3	0,2	2	9,525	3,18	9,80 €
1331168	1331183	RT16R/L150-R02 RT305	1,5	0,2	2	9,525	3,18	9,80 €
1331169	1331184	RT16R/L160-R02 RT305	1,6	0,2	2	9,525	3,18	9,80 €
1331170	1331185	RT16R/L165-R02 RT305	1,65	0,2	2	9,525	3,18	9,80 €
1331171	1331186	RT16R/L185-R02 RT305	1,85	0,2	2,5	9,525	3,18	9,80 €
1331172	1331187	RT16R/L200-R02 RT305	2,0	0,2	2,5	9,525	3,18	9,80 €
1331173	1331188	RT16R/L220-R02 RT305	2,2	0,2	2,5	9,525	3,18	9,80 €
1331174	1331189	RT16R/L250-R02 RT305	2,5	0,2	2,5	9,525	3,18	9,80 €
1331175	1331190	RT16R/L300-R02 RT305	3,0	0,2	3	9,525	3,18	9,80 €

RT16-STECHSYSTEM - AUSSENSTECHEN



Abbildung zeigt R

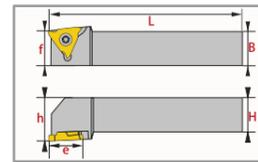

Art. Nr. R	Art. Nr. L	ØDmin	L	h	e	H=f=B	Stechbreite		
1331062	1331061	GQCR/L 1616 K16-15	16	125	21	25,5	16	0,5 - 1,8 mm	54,00 €
1331064	1331063	GQCR/L 2020 K16-15	20	125	25	25,5	20	0,5 - 1,8 mm	54,00 €
1331066	1331065	GQCR/L 2525 M16-15	25	150	30	25,5	25	0,5 - 1,8 mm	54,00 €
1331068	1331067	GQCR/L 1616 K16-25	16	125	21	25,5	16	1,8 - 3 mm	54,00 €
1331070	1331069	GQCR/L 2020 K16-25	20	125	25	25,5	20	1,8 - 3 mm	54,00 €
1331072	1331071	GQCR/L 2525 M16-25	25	150	30	25,5	25	1,8 - 3 mm	54,00 €

BITTE BEACHTEN: Rechter Halter = rechte Stechplatte (RT16R...) Linker Halter = linke Stechplatte (RT16L...)

Zubehör



SCHRAUBE
IPM3,5x10 (T15)

RT-16-STECHSYSTEM - INNENDREHHALTER



Abbildung zeigt R

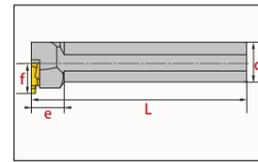

Art. Nr. R	Art. Nr. L	Dmin	d	L	f	e	Stechbreite		
1441141	1441143	S20M-QC1615R/L25	26	20	150	12,5	15	0,5 - 1,80mm	64,00 €
1441142	1441144	S20M-QC1625R/L25	26	20	150	12,5	15	1,8 - 3,0mm	64,00 €

BITTE BEACHTEN: Rechte Bohrstange = linke Stechplatte (RT16L....) Linke Bohrstange = rechte Stechplatte (RT16R...)

Zubehör



SCHRAUBE
IPM2,5x6,5 (T07)

N151.2...-4E RT300

P M Kompatibel zu SANDVIK N151.2...

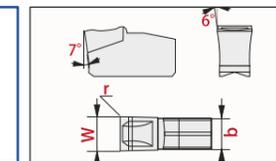

Art. Nr.	W	b	r		
1331321	N151.2-300-4E RT300	3,0	2,5	0,25	4,95 €
1331322	N151.2-400-4E RT300	4,0	3,3	0,25	5,20 €

AUSSENGEWINDE LINKS

GEWINDE:
- AUSSEN
- LINKS

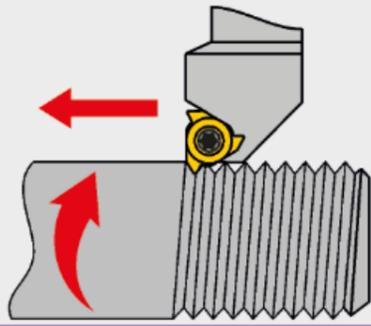

16EL METRISCH

P M - LINKS
- AUSSEN



ART. Nr.	RT315	
1881151	16EL-V-ISO-1,0 RT315	7,90 €
1881152	16EL-V-ISO-1,25 RT315	7,90 €
1881153	16EL-V-ISO-1,5 RT315	7,90 €
1881154	16EL-V-ISO-1,75 RT315	7,90 €
1881155	16EL-V-ISO-2,0 RT315	7,90 €
1881156	16EL-V-ISO-2,5 RT315	7,90 €
1881157	16EL-V-ISO-3,0 RT315	7,90 €

16EL ZÖLLIG

P M - LINKS
- AUSSEN



ART. Nr.	RT315	
1881161	16EL-V-BSW-11 RT315 (55°)	7,90 €
1881162	16EL-V-BSW-14 RT315 (55°)	7,90 €
1881163	16EL-V-BSW-19 RT315 (55°)	7,90 €

22EL METRISCH

P M - LINKS
- AUSSEN



ART. Nr.	RT315	
1881211	22EL-V-ISO-4,0 RT315	12,50 €
1881212	22EL-V-ISO-4,5 RT315	12,50 €
1881213	22EL-V-ISO-5,0 RT315	12,50 €
1881214	22EL-V-ISO-5,5 RT315	12,50 €
1881215	22EL-V-ISO-6,0 RT315	12,50 €

AUSSENGEWINDEDREHHALTER TEL



Art.Nr. L		h=H	b	L	f	
SM34808	TEL 1616 H16	16	16	100	16	39,00 €
SM29835	TEL 2020 K16	20	20	125	20	39,00 €
SM29859	TEL 2525 M16	25	25	150	25	44,00 €
SM34853	TEL 2525 M22	25	25	150	25	44,00 €
SM34877	TEL 3232 P22	32	32	170	32	52,00 €

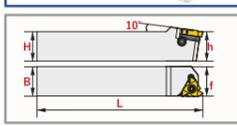

Zubehör TEL

	SCHRAUBE	UNTERLEGPLATTE EL	UP-SCHRAUBE
16EL	M3,5x12 (T15)	BAX TEL-16 - 9626	TASV1 M3x9 - 9220
22EL	SSV M4x14 -9516 (T15)	BAX TEL-22 - 9628	TASV2 M4x12 - 9221

P Stahl **M** Edelstahl **K** Guss **S** Sonderwerkstoffe **H** Harte Werkstoffe **N** NE-Metalle
Komplette Träger-Zubehörliste mit Art. Nr. und Preise auf Seite 81.

AUSSENGEWINDE RECHTS

GEWINDE:
- AUSSEN
- RECHTS

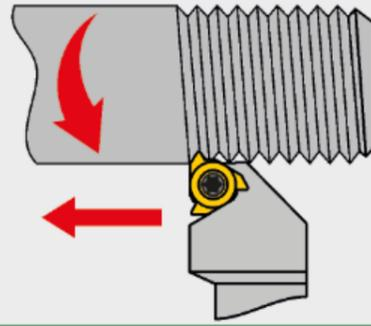

16ER METRISCH

M - RECHTS
- AUSSEN



ART. Nr.	RT300	
1881021	16ER-V-ISO-1,0 RT300	7,40 €
1881022	16ER-V-ISO-1,25 RT300	7,40 €
1881023	16ER-V-ISO-1,5 RT300	7,40 €
1881024	16ER-V-ISO-1,75 RT300	7,40 €
1881025	16ER-V-ISO-2,0 RT300	7,40 €
1881026	16ER-V-ISO-2,5 RT300	7,40 €
1881027	16ER-V-ISO-3,0 RT300	7,40 €

16ER ZÖLLIG

P M - RECHTS
- AUSSEN

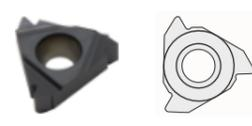

ART. Nr.	RT315	
1881125	16ER-V-BSW-08 RT315 (55°)	7,90 €
1881126	16ER-V-BSW-09 RT315 (55°)	7,90 €
1881127	16ER-V-BSW-10 RT315 (55°)	7,90 €
1881128	16ER-V-BSW-12 RT315 (55°)	7,90 €
1881130	16ER-V-BSW-16 RT315 (55°)	7,90 €
1881131	16ER-V-BSW-18 RT315 (55°)	7,90 €

16ER METRISCH

P M K N - RECHTS
- AUSSEN



ART. Nr.	RT330	
1881041	16ER-V-ISO-1,0 RT330	7,40 €
1881042	16ER-V-ISO-1,25 RT330	7,40 €
1881043	16ER-V-ISO-1,5 RT330	7,40 €
1881044	16ER-V-ISO-1,75 RT330	7,40 €
1881045	16ER-V-ISO-2,0 RT330	7,40 €
1881046	16ER-V-ISO-2,5 RT330	7,40 €
1881047	16ER-V-ISO-3,0 RT330	7,40 €
1881051	16ER-V-ISO-3,0 RT330	7,40 €

16ER ZÖLLIG

M - RECHTS
- AUSSEN



ART. Nr.	RT300	
1881028	16ER-V-BSW-11 RT300 (55°)	7,40 €
1881029	16ER-V-BSW-14 RT300 (55°)	7,40 €
1881030	16ER-V-BSW-19 RT300 (55°)	7,40 €

22ER METRISCH

P M K N - RECHTS
- AUSSEN



ART. Nr.	RT330	
1881101	22ER-V-ISO-4,0 RT330	12,50 €
1881102	22ER-V-ISO-4,5 RT330	12,50 €
1881103	22ER-V-ISO-5,0 RT330	12,50 €
1881104	22ER-V-ISO-5,5 RT330	12,50 €
1881105	22ER-V-ISO-6,0 RT330	12,50 €

16ER ZÖLLIG

P M K N - RECHTS
- AUSSEN



ART. Nr.	RT330	
1881048	16ER-V-BSW-11 RT330 (55°)	7,40 €
1881049	16ER-V-BSW-14 RT330 (55°)	7,40 €
1881050	16ER-V-BSW-19 RT330 (55°)	7,40 €

AUSSENGEWINDEDREHHALTER TER



Art.Nr. R		h=H	b	L	f	
SM34815	TER 1616 H16	16	16	100	16	39,00 €
SM29828	TER 2020 K16	20	20	125	20	39,00 €
SM29842	TER 2525 M16	25	25	150	25	44,00 €
SM34846	TER 2525 M22	25	25	150	25	44,00 €
SM34860	TER 3232 P22	32	32	170	32	52,00 €

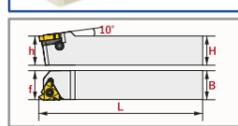

Zubehör TER

	SCHRAUBE	UNTERLEGPLATTE ER	UP-SCHRAUBE
16ER	M3,5x12 (T15)	BAX TER-16 - 9625	TASV1 M3x9 - 9220
22ER	SSV M4x14 -9516 (T15)	BAX TER-22 - 9627	TASV2 M4x12 - 9221

INNENGEWINDE LINKS

GEWINDE:
- INNEN
- LINKS

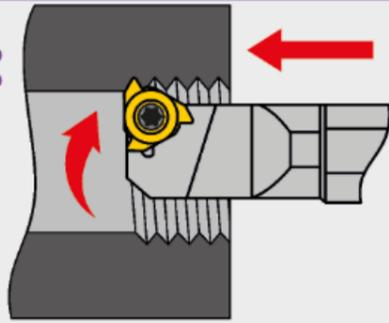

11IL METRISCH

P M - LINKS
- INNEN

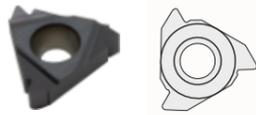

Art. Nr.	RT315	
1881241	11IL-V-ISO-1,0 RT315	7,90 €
1881242	11IL-V-ISO-1,25 RT315	7,90 €
1881243	11IL-V-ISO-1,5 RT315	7,90 €
1881244	11IL-V-ISO-1,75 RT315	7,90 €
1881245	11IL-V-ISO-2,0 RT315	7,90 €

16IL ZÖLLIG

P M - LINKS
- INNEN

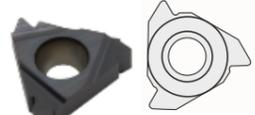

Art. Nr.	RT315	
1881226	16IL-V-BSW-11 RT315 (55°)	7,90 €
1881227	16IL-V-BSW-14 RT315 (55°)	7,90 €
1881228	16IL-V-BSW-19 RT315 (55°)	7,90 €

16IL METRISCH

P M - LINKS
- INNEN

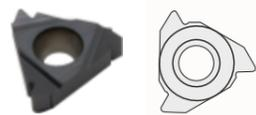

Art. Nr.	RT315	
1881071	16IL-V-ISO-1,0 RT315	7,90 €
1881072	16IL-V-ISO-1,25 RT315	7,90 €
1881073	16IL-V-ISO-1,5 RT315	7,90 €
1881074	16IL-V-ISO-1,75 RT315	7,90 €
1881075	16IL-V-ISO-2,0 RT315	7,90 €
1881076	16IL-V-ISO-2,5 RT315	7,90 €
1881077	16IL-V-ISO-3,0 RT315	7,90 €

22IL METRISCH

P M - LINKS
- INNEN



Art. Nr.	RT315	
1881202	22IL-V-ISO-4,0 RT315	12,50 €
1881203	22IL-V-ISO-4,5 RT315	12,50 €
1881204	22IL-V-ISO-5,0 RT315	12,50 €
1881205	22IL-V-ISO-5,5 RT315	12,50 €
1881206	22IL-V-ISO-6,0 RT315	12,50 €



INNENGEWINDEDREHHALTER SIL/TIL...

Art.Nr.		d	d1	H	L	f	L1	Dmin	
SM11847	S10K SIL-11	10	10	09	125	7	-	12	32,00 €
SM11861	S12K SIL-11	12	12	11	125	10	-	16	32,00 €
SM12004	S16x13M SIL-16	16	16	15	150	10	32	16	37,00 €
SM11953	S16M SIL-16	16	13	15	150	11	-	19	37,00 €
SM11960	S20P SIL-16	20	20	18	170	14	-	24	37,00 €
SM44692	S25R TIL-16	25	25	23	200	16,5	-	29	44,00 €
SM44715	S32S TIL-16	32	32	30	250	20	-	36	59,00 €
SM44753	S25R TIL-22	25	25	23	200	16,5	-	29	44,00 €
SM44777	S32S TIL-22	32	32	30	250	20	-	38	59,00 €

Zubehör SIR/L TIR/L

	SCHRAUBE	UNTERLEGPLATTE IR	UNTERLEGPLATTE IL	UP-SCHRAUBE
11ER/L	SSV M2,5x6-9505 (T08)	---	---	---
16ER/L S16x13M	SSV M3,5x8 -9510 (T15)	---	---	---
16ER/L S16M, S20P	SSV M3,5x10 -9511 (T15)	---	---	---
16ER/L S25R, S32S	SSV M3,5x14 -9512 (T15)	BAX TER-16 - 9625	BAX TEL-16 - 9626	TASV1 M3x9 - 9220 (T15)
22ER S25R, S32S	SSV M4x14 -9516 (T15)	BAX TER-22 - 9627	BAX TEL-22 - 9628	TASV1 M4x12 - 9221 (T20)

P Stahl **M** Edelstahl **K** Guss **S** Sonderwerkstoffe **H** Harte Werkstoffe **N** NE-Metalle

Komplette Träger-Zubehörliste mit Art. Nr. und Preise auf Seite 81.

INNENGEWINDE RECHTS

GEWINDE:
- INNEN
- RECHTS

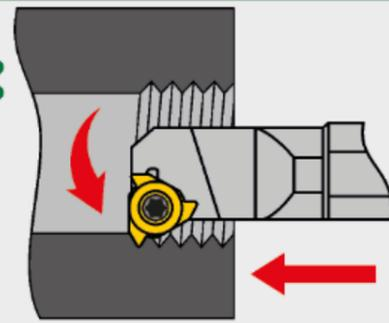

11IR METRISCH

P M K N - RECHTS
- INNEN



Art. Nr.	RT330	
1881001	11IR-V-ISO-0,75 RT330	7,40 €
1881002	11IR-V-ISO-1,0 RT330	7,40 €
1881003	11IR-V-ISO-1,25 RT330	7,40 €
1881004	11IR-V-ISO-1,5 RT330	7,40 €
1881005	11IR-V-ISO-1,75 RT330	7,40 €
1881006	11IR-V-ISO-2,0 RT330	7,40 €

16IR ZÖLLIG

P M - RECHTS
- INNEN



Art. Nr.	RT315	
1881147	16IR-V-BSW-08 RT315 (55°)	7,90 €
1881141	16IR-V-BSW-09 RT315 (55°)	7,90 €
1881142	16IR-V-BSW-10 RT315 (55°)	7,90 €
1881143	16IR-V-BSW-12 RT315 (55°)	7,90 €
1881145	16IR-V-BSW-16 RT315 (55°)	7,90 €
1881146	16IR-V-BSW-18 RT315 (55°)	7,90 €

16IR METRISCH

M - RECHTS
- INNEN



Art. Nr.	RT300	
1881061	16IR-V-ISO-1,0 RT300	7,40 €
1881062	16IR-V-ISO-1,25 RT300	7,40 €
1881063	16IR-V-ISO-1,5 RT300	7,40 €
1881064	16IR-V-ISO-1,75 RT300	7,40 €
1881065	16IR-V-ISO-2,0 RT300	7,40 €
1881066	16IR-V-ISO-2,5 RT300	7,40 €
1881067	16IR-V-ISO-3,0 RT300	7,40 €

16IR ZÖLLIG

M - RECHTS
- INNEN



Art. Nr.	RT300	
1881068	16IR-V-BSW-11 RT300 (55°)	7,40 €
1881069	16IR-V-BSW-14 RT300 (55°)	7,40 €
1881070	16IR-V-BSW-19 RT300 (55°)	7,40 €

16IR METRISCH

P M K N - RECHTS
- INNEN



Art. Nr.	RT330	
1881081	16IR-V-ISO-1,0 RT330	7,40 €
1881082	16IR-V-ISO-1,25 RT330	7,40 €
1881083	16IR-V-ISO-1,5 RT330	7,40 €
1881084	16IR-V-ISO-1,75 RT330	7,40 €
1881085	16IR-V-ISO-2,0 RT330	7,40 €
1881086	16IR-V-ISO-2,5 RT330	7,40 €
1881087	16IR-V-ISO-3,0 RT330	7,40 €
1881091	16IR-V-ISO-3,5 RT330	7,40 €

16IR ZÖLLIG

P M K N - RECHTS
- INNEN



Art. Nr.	RT330	
1881088	16IR-V-BSW-11 RT330 (55°)	7,40 €
1881089	16IR-V-BSW-14 RT330 (55°)	7,40 €
1881090	16IR-V-BSW-19 RT330 (55°)	7,40 €

22IR METRISCH

P M K N - RECHTS
- INNEN



Art. Nr.	RT330	
1881111	22IR-V-ISO-4,0 RT330	12,50 €
1881112	22IR-V-ISO-4,5 RT330	12,50 €
1881113	22IR-V-ISO-5,0 RT330	12,50 €
1881114	22IR-V-ISO-5,5 RT330	12,50 €
1881115	22IR-V-ISO-6,0 RT330	12,50 €



INNENGEWINDEDREHHALTER SIR/TIR

Art.Nr.		d	d1	H	L	f	L1	Dmin	
SM11830	S10K SIR-11	10	10	09	125	7	-	12	32,00 €
SM11854	S12K SIR-11	12	12	11	125	10	-	16	32,00 €
SM11991	S16x13M SIR-16	16	16	15	150	10	32	16	37,00 €
SM11915	S16M SIR-16	16	13	15	150	11	-	19	37,00 €
SM11922	S20P SIR-16	20	20	18	170	14	-	24	37,00 €
SM44685	S25R TIR-16	25	25	23	200	16,5	-	29	44,00 €
SM44708	S32S TIR-16	32	32	30	250	20	-	36	59,00 €
SM44746	S25R TIR-22	25	25	23	200	16,5	-	29	44,00 €
SM44760	S32S TIR-22	32	32	30	250	20	-	38	59,00 €

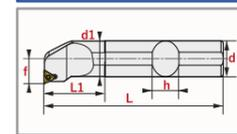

MICROZERSPANUNG

VOLLHARTMETALL-BOHRSTANGE FÜR MICROZERSPANUNG SCLCL-03



Art. Nr.		D	L	d	Dmin	
1991015	E04J-SCLCR-03 (CCGT 030102L)	4	90	2,5	5	88,00 €
1991011	E04J-SCLCL-03 (CCGT 030102R)	4	90	2,5	5	88,00 €
1991016	E05J-SCLCR-03 (CCGT 030102L)	5	100	3	6	88,00 €
1991012	E05J-SCLCL-03 (CCGT 030102R)	5	100	3	6	88,00 €
1991017	E06J-SCLCR-03 (CCGT 030202L)	6	110	3,5	7	88,00 €
1991013	E06J-SCLCL-03 (CCGT 030202R)	6	110	3,5	7	88,00 €

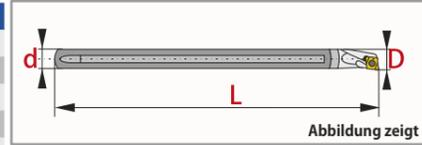

BITTE BEACHTEN:
Rechte Bohrstanze = linke Platte - Linke Bohrstanze = rechte Platte

BOHRSTANGEHALTER

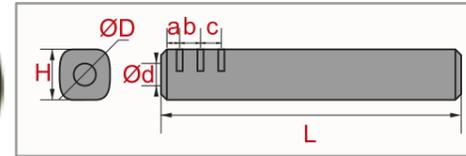

Art. Nr.		Ød	a	b	c	ØD	H	L	
1991031	SL1604 (FÜR E04... BOHRSTANGEN)	4	5	6	-	16	14	100	26,00 €
1991032	SL1605 (FÜR E05... BOHRSTANGEN)	5	5	8	-	16	14	100	26,00 €
1991033	SL1606 (FÜR E06... BOHRSTANGEN)	6	5	6	6	16	14	100	26,00 €

P M N WENDESCHNEIDPLATTEN FÜR MICROZERSPANUNG CCGT 03..

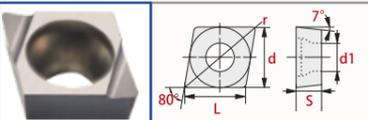

Art. Nr.		L	d	S	r	d1	
1991022	CCGT 030102R RT200	3,30	3,50	1,39	0,2	1,90	6,40 €
1991023	CCGT 030102L RT200	3,30	3,50	1,39	0,2	1,90	6,40 €

BITTE BEACHTEN:
Rechte Bohrstanze = linke Platte - Linke Bohrstanze = rechte Platte

VHM-MICROZERSPANUNG-SET



Art. Nr.	Set bestehend aus:			
1991057	SET 4 MM R	1 HALTER SL1604, 1 BOHRSTANGE E04G-SCLCR-03, 5 WENDEPLATTEN CCGT 030102L RT200		139,00 €
1991054	SET 4 MM L	1 HALTER SL1604, 1 BOHRSTANGE E04G-SCLCL-03, 5 WENDEPLATTEN CCGT 030102R RT200		139,00 €
1991058	SET 5 MM R	1 HALTER SL1605, 1 BOHRSTANGE E05G-SCLCR-03, 5 WENDEPLATTEN CCGT 030102L RT200		139,00 €
1991055	SET 5 MM L	1 HALTER SL1605, 1 BOHRSTANGE E05G-SCLCL-03, 5 WENDEPLATTEN CCGT 030102R RT200		139,00 €
1991059	SET 6 MM R	1 HALTER SL1606, 1 BOHRSTANGE E06G-SCLCR-03, 5 WENDEPLATTEN CCGT 030102L RT200		139,00 €
1991056	SET 6 MM L	1 HALTER SL1606, 1 BOHRSTANGE E06G-SCLCL-03, 5 WENDEPLATTEN CCGT 030102R RT200		139,00 €

MULTI-CUT-TOOL FÜR XCMT/XCGT



Multifunktionswerkzeug Bohren - Drehen - Planen

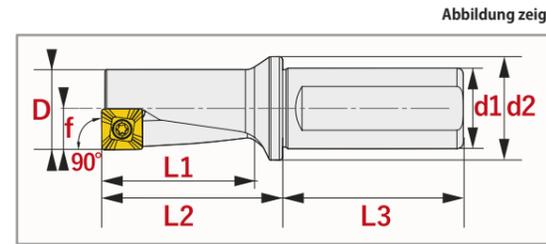
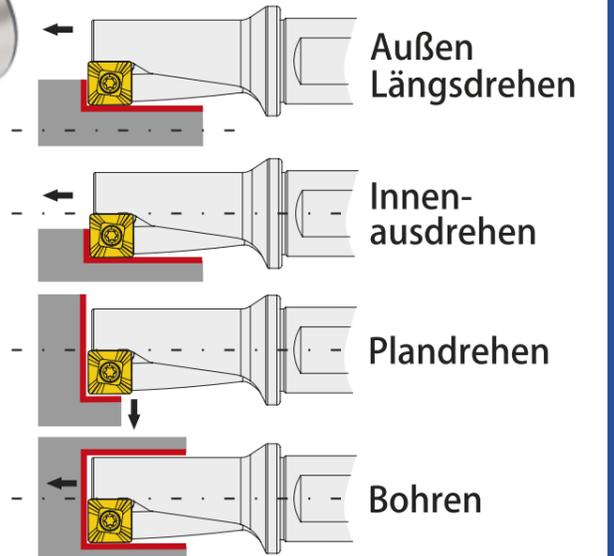

Art. Nr.		d	d1	d2	L1	L2	L3	f	
SM33313	SMCR 10x2,5 XC..05..	10	12	16	25	30	42	5	84,00 €
SM55025	SMCL 10x2,5 XC..05..	10	12	16	25	30	42	5	84,00 €
SM33337	SMCR 12x2,5 XC..06..	12	16	20	30	35	45	6	84,00 €
SM55032	SMCL 12x2,5 XC..06..	12	16	20	30	35	45	6	84,00 €
SM33344	SMCR 16x2,5 XC..08..	16	20	25	40	45	50	8	94,00 €
SM55049	SMCL 16x2,5 XC..08..	16	20	25	40	45	50	8	94,00 €
SM33399	SMCR 20x2,5 XC..10..	20	25	32	50	55	56	10	99,00 €
SM55056	SMCL 20x2,5 XC..10..	20	25	32	50	55	56	10	99,00 €
SM33405	SMCR 25x2,5 XC..13..	25	32	40	62,5	69	60	12,5	107,00 €
SM55063	SMCL 25x2,5 XC..13..	25	32	40	62,5	69	60	12,5	107,00 €
SM33757	SMCR 32x2,5 XC..17..	32	40	50	80	88	70	16	109,00 €
SM55070	SMCL 32x2,5 XC..17..	32	40	50	80	88	70	16	109,00 €

Zubehör

SCHRAUBE	
10x2,5 XC05 : IPM2x4,3 (T06)	16x2,5 XC08: SSV M3x6-9507 (T08)
12x2,5 XC06: M2,2x5 (T07)	20x2,5 XC10: SSV M3,5x8-SC - 9513 (T10)
	25x2,5 XC13, 32x2,5 XC17: SSV M4,5x11 - 9518 (T20)

P M WENDESCHNEIDPLATTEN XCMT

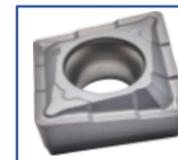

Art. Nr.		L	d	S	r	Ød1	Anwendung	
3701205	XCMT 050204-EN RT300	6,0	6,4	2,38	0,4	2,5	STAHL/EDELSTAHL	8,90 €
3701201	XCMT 060204-EN RT300	6,0	6,4	2,38	0,4	2,5	STAHL/EDELSTAHL	8,90 €
3701202	XCMT 080304-EN RT300	8,0	8,4	3,18	0,4	3,4	STAHL/EDELSTAHL	9,20 €
3701203	XCMT 10T304-EN RT300	10	10,4	3,97	0,4	4,0	STAHL/EDELSTAHL	10,50 €
3701204	XCMT 130408-EN RT300	12,7	13,5	4,67	0,8	5,5	STAHL/EDELSTAHL	12,20 €
3701206	XCMT 170508-EN RT300	12,7	13,5	4,67	0,8	5,5	STAHL/EDELSTAHL	13,60 €

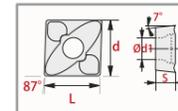

N WENDESCHNEIDPLATTEN XCGT



Art. Nr.		L	d	S	r	Ød1	Anwendung	
3701221	XCGT 050204-ALZ RT100	6,0	6,4	2,38	0,4	2,5	NE-METALLE	10,20 €
3701222	XCGT 060204-ALZ RT100	6,0	6,4	2,38	0,4	2,5	NE-METALLE	10,20 €
3701223	XCGT 080304-ALZ RT100	8,0	8,4	3,18	0,4	3,4	NE-METALLE	10,50 €
3701224	XCGT 10T304-ALZ RT100	10	10,4	3,97	0,4	4,0	NE-METALLE	12,10 €
3701225	XCGT 130408-ALZ RT100	12,7	13,5	4,67	0,8	5,5	NE-METALLE	14,30 €
3701226	XCGT 170508-ALZ RT100	12,7	13,5	4,67	0,8	5,5	NE-METALLE	15,60 €

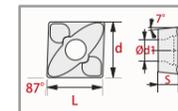

SEET PLANFRÄSER

Positiv angestellte Wendepatten für einen weichen Schnitt

SEET.. WENDESCHNEIDPLATTEN

4 SCHNEIDEN - KOMPATIBEL ZU SANDVIK R245... + SEKT/SEMT, MITSUBISHI, SUMITOMO



Art. Nr.		L	I.C.	S	d	bs	
2651017	SEET 12T3-PM RT300	13,4	13,4	3,97	4,1	2,55	4,90 €
2651016	SEET 12T3-DM RT150K	13,4	13,4	3,97	4,1	2,55	4,90 €
2651011	SEET 12T3-ALZ RT100	13,4	13,4	3,97	4,1	2,55	4,90 €
2651013	SEET 12T3-DM RT300P	13,4	13,4	3,97	4,1	2,55	4,90 €
2651018	SEET 12T3-DF RTC	13,4	13,4	3,97	4,1	2,55	4,90 €

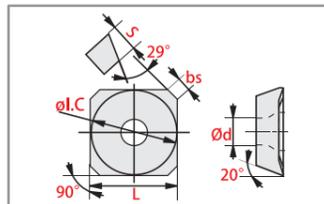

PLANFRÄSER TK45 SE12/SEET 12T3



Art. Nr.		D	d	L	a	Z	
SM08982	TK45 SE12 D50 A22 Z04-H MIT IK	*	50	22	40	6	4 69,00 €
SM28975	TK45 SE12 D63 A22 Z05-H MIT IK	*	63	22	40	6	5 79,00 €
SM28968	TK45 SE12 D80 A27 Z06-H MIT IK	*	80	27	50	6	6 96,00 €
SM28951	TK45 SE12 D100 A32 Z07-H MIT IK	*	100	32	50	6	7 119,00 €
SM14800	TK45 SE12 D125 B40 Z08		125	40	63	6	8 149,00 €

* = MIT KÜHLKANÄLEN - WITH COOLING HOLES

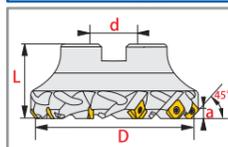

Zubehör

SCHRAUBE
M3,5x10 (T15)

SNEG: DIE NEUE PLANFRÄSERGENERATION

- Doppelseitige, extra dicke Wendschneidplatten mit 8 Schneidkanten.
- Großer Spanwinkel reduziert Schnittkräfte
- Für große Spantiefen bei hoher Bruchsicherheit

SNEG WENDESCHNEIDPLATTEN



Art. Nr.		L	I.C.	S	d	r	bs	
2651051	SNEG1205-GM RT150K	12	12	4,76	4,6	0,8	1,05	8,90 €
2651052	SNEG1205-GM RT250X	12	12	4,76	4,6	0,8	1,05	8,90 €

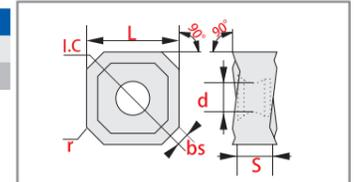

SNEG PLANFRÄSER



Art. Nr.		D	d	L	a	Z	
2451025	MK45 SNEG12 D050 A22 Z05-H	*	50	22	40	7	5 99,00 €
2451021	MK45 SNEG12 D063 A22 Z06-H	*	63	22	40	7	6 117,00 €
2451022	MK45 SNEG12 D080 A27 Z07-H	*	80	27	50	7	7 149,00 €
2451023	MK45 SNEG12 D100 A32 Z09-H	*	100	32	50	7	9 172,00 €
2451024	MK45 SNEG12 D125 B40 Z11		125	40	63	7	11 224,00 €

* = MIT KÜHLKANÄLEN - WITH COOLING HOLES

Zubehör

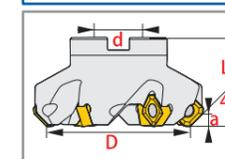
SCHRAUBE
SSV M4x12x5-9529 (T15)

LNMX 0303 HOCHVORSCHUBFRÄSER

- Ab Ø16 mm durch kompaktes WSP-Design
- Weichschneidende Geometrie für geringe Schnittkräfte.
- Erhöhtes Zeitspannungsvolumen - auch bei leistungsschwachen Maschinen
- Doppelseitige Wendeschneidplatte mit 4 Schneiden für hohe Wirtschaftlichkeit



HTK LNMX 0303 HOCHVORSCHUB-MESSERKOPF

Art. Nr.	D	d	L	Z	ap max	
SM45460 HTK LN03 D40 A16 Z05-H *	40	16	40	5	1	92,00 €
SM45477 HTK LN03 D50 A22 Z07-H *	50	22	40	7	1	108,00 €

Wendeschneidplatte (Milling Inserts): LNMX 0303...

* = MIT KÜHLKANÄLEN - WITH COOLING HOLES

Zubehör



SCHRAUBE
SSV M2,5x7 - 9506 (T08)

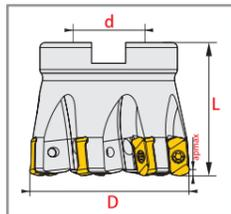

HST LNMX 0303 HOCHVORSCHUB-SCHAFTFRÄSER

Art. Nr.	D	d	L	l	Z	ap max	
SM45507 HST LN03 D16 W16 L150 Z02-H *	16	16	150	40	2	1	88,00 €
SM45514 HST LN03 D20 W20 L150 Z03-H *	20	20	150	40	3	1	94,00 €
SM45521 HST LN03 D25 W25 L150 Z04-H *	25	25	150	40	4	1	107,00 €
SM52857 HST LN03 D32 W32 L150 Z05-H *	32	32	150	40	5	1	139,20 €

Wendeschneidplatte (Milling Inserts): LNMX 0303...

* = MIT KÜHLKANÄLEN - WITH COOLING HOLES

Zubehör



SCHRAUBE
D16 SSV M2,5x6 - 9505 (T08)
AB D20 SSV M2,5x7 - 9506 (T08)

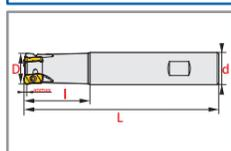

MHT LNMX 0303 HOCHVORSCHUB-EINSCHRAUBFRÄSER

Art. Nr.	D	d1	d2	L	l	M	Z	ap max	
SM45552 MHT LN03 D16 M08 L25 Z02-H *	16	15	8,5	25	17	8	2	1	79,00 €
SM45569 MHT LN03 D20 M10 L30 Z03-H *	20	18	10,5	30	19	10	3	1	93,00 €
SM45576 MHT LN03 D25 M12 L35 Z04-H *	25	21	12,5	35	23	12	4	1	99,00 €
SM51959 MHT LN03 D32 M16 L43 Z05-H *	32	29	17	43	23	16	5	1	103,00 €
SM00272 MHT LN03 D35 M16 L43 Z05-H *	35	29	17	43	23	16	5	1	103,00 €
SM00265 MHT LN03 D42 M16 L43 Z06-H *	42	29	17	43	23	16	6	1	105,00 €

Wendeschneidplatte (Milling Inserts): LNMX 0303...

* = MIT KÜHLKANÄLEN - WITH COOLING HOLES

Zubehör



SCHRAUBE
D16 SSV M2,5x6 - 9505 (T08)
AB D20 SSV M2,5x7 - 9506 (T08)

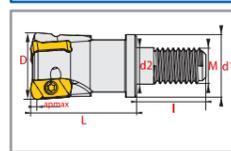

LNMX 0303-MU RT300

Art. Nr.	L	W	S	r	ap max	
2301060 LNMX 0303-MU RT300	11,86	6	4,29	1,20	1	4,70 €

Schnittdaten

LNMX 0303-MU RT300 $V_C = 80-150\text{M}/\text{MIN} - F_Z = 0,3-1,1\text{ MM}$

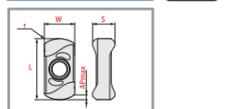

LNMX 0904 HOCHVORSCHUBFRÄSER

- Große WSP für höhere Vorschübe und Zustelltiefen
- Weichschneidende Geometrie für geringe Schnittkräfte.
- Erhöhtes Zeitspannungsvolumen - auch bei leistungsschwachen Maschinen
- Doppelseitige Wendeschneidplatte mit 4 Schneiden für hohe Wirtschaftlichkeit



HTK LNMX 0904 HOCHVORSCHUB-MESSERKOPF

Art. Nr.	D	d	L	Z	ap max	
SM28050 HTK BL09 D40 A16 Z05-H *	40	16	40	5	1,5	75,00 €
SM28043 HTK BL09 D50 A22 Z06-H *	50	22	40	6	1,5	92,00 €
SM22607 HTK BL09 D63 A22 Z07-H *	63	22	40	7	1,5	102,00 €
NP63433 HTK BL09 D80 A27 Z10-H *	80	27	50	10	1,5	149,00 €
NP63440 HTK BL09 D100 A32 Z12-H *	100	32	50	12	1,5	195,00 €

Wendeschneidplatte (Milling Inserts): LNMX 0904...

* = MIT KÜHLKANÄLEN - WITH COOLING HOLES

Zubehör



SCHRAUBE
SSV M3,5x8-SC-9513 (T10)

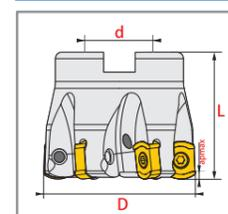

HST LNMX 0904 HOCHVORSCHUB-SCHAFTFRÄSER

Art. Nr.	D	d	L	l	Z	ap max	
SM58859 HST BL09 D25 W25 L150 Z03-H *	25	25	150	40	3	1,5	116,00 €
SM58873 HST BL09 D32 W32 L150 Z04-H *	32	32	150	40	4	1,5	125,00 €

Wendeschneidplatte (Milling Inserts): LNMX 0904...

* = MIT KÜHLKANÄLEN - WITH COOLING HOLES

Zubehör



SCHRAUBE
SSV M3,5x8-SC-9513 (T10)

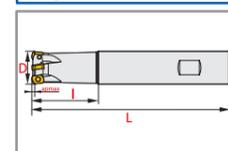

MHT LNMX 0904 HOCHVORSCHUB-EINSCHRAUBFRÄSER

Art. Nr.	D	d1	d2	L	l	M	Z	ap max	
SM58897 MHT BL09 D25 M12 L35 Z03-H *	25	21	12,5	35	23	12	3	1,5	88,00 €
SM58903 MHT BL09 D32 M16 L43 Z04-H *	32	29	17	43	23	16	4	1,5	93,00 €
SM58910 MHT BL09 D35 M16 L43 Z04-H *	35	29	17	43	23	16	4	1,5	93,00 €
SM58927 MHT BL09 D40 M16 L43 Z05-H *	40	29	17	43	23	16	5	1,5	105,00 €

Wendeschneidplatte (Milling Inserts): LNMX 0904...

* = MIT KÜHLKANÄLEN - WITH COOLING HOLES

Zubehör



SCHRAUBE
SSV M3,5x8-SC-9513 (T10)

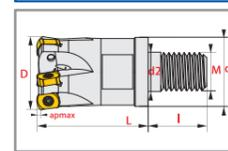

LNMX 0904-MU RT330

Art. Nr.	L	W	S	r	ap max	
2301065 LNMX 0904-MU RT330	11,94	9,2	4,79	1,20	1,5	5,90 €

Schnittdaten

LNMX 0904-MU RT330 $V_C = 80-180\text{M}/\text{MIN} - F_Z = 0,6-1,5\text{ MM}$

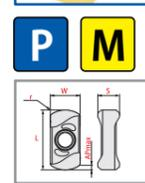

ANGX: ECKFRÄSER MIT DOPPELSEITIGEN WENDEPLATTEN

- Speziell entwickelte Schneidkanten für hochwertiges 90° Eckfräsen.
- Extra dicke Wendeschneidplatten zur Verbesserung der Bruchfestigkeit
- Weichschneidende Geometrie für reduzierte Schnittkräfte
- Polierte, hochpräzise Geometrie für Aluminiumlegierungen

ANGX WENDESCHNEIDPLATTEN



P
M



K



N

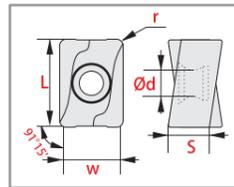

Art. Nr.	ANGX 11	L	S	d	W	r	
2701221	ANGX 110508-GM RT150K	11,85	5,7	3,5	8,4	0,8	8,90 €
2701222	ANGX 110508-GM RT250X	11,85	5,7	3,5	8,4	0,8	8,90 €
2701223	ANGX 110504-ALZ RT100	11,85	5,7	3,5	8,4	0,4	8,90 €

Art. Nr.	ANGX 15	L	S	d	W	r	
2701224	ANGX 150608-GM RT150K	15,43	7,3	4,4	11	0,8	9,40 €
2701225	ANGX 150608-GM RT250X	15,43	7,3	4,4	11	0,8	9,40 €
2701226	ANGX 150608-ALZ RT100	15,43	7,3	4,4	11	0,8	9,40 €



ECKFRÄSER AN... MIT KÜHLKANÄLEN

Art. Nr.		D	d	L	Z	ap max	
2101021	MK90 AN11 D040 A16 Z05-H	40	16	40	5	11,2	59,00 €
2101022	MK90 AN11 D050 A22 Z06-H	50	22	40	6	11,2	68,00 €
2101023	MK90 AN11 D063 A22 Z07-H	63	22	40	7	11,2	84,00 €
2101025	MK90 AN15 D050 A22 Z04-H	50	22	40	4	14,5	68,00 €
2101026	MK90 AN15 D063 A22 Z05-H	63	22	40	5	14,5	79,00 €
2101027	MK90 AN15 D080 A27 Z07-H	80	27	50	7	14,5	99,00 €
2101028	MK90 AN15 D100 B32 Z09-H	100	32	50	9	14,5	124,00 €

Zubehör



SCHRAUBE

ANGX 11 D040 - D063	SSV M3x8 - 9508 (T08)
ANGX 11 D080	IPM 3x9 (T09)
ANGX 15	SSV M4x12x5 - 9529 (T15)

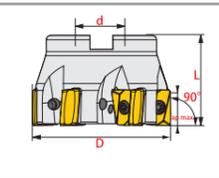

SCHAFTFRÄSER AN... MIT KÜHLKANÄLEN

Art. Nr.		D	d	L	Z	ap max	
2101001	SF90 AN11 D25 W25 L100 Z2	25	25	100	2	11,2	69,00 €
2101002	SF90 AN11 D32 W32 L115 Z3	32	32	115	3	11,2	94,00 €
2101003	SF90 AN15 D32 W32 L125 Z2	32	32	125	2	14,5	69,00 €
2101004	SF90 AN15 D40 W32 L125 Z3	40	32	125	3	14,5	94,00 €

Zubehör



SCHRAUBE

ANGX 11	IPM 3x9 (T09)
ANGX 15	IPM 4x12 (T15)

P Stahl **M** Edelstahl **K** Guss **S** Sonderwerkstoffe **H** Harte Werkstoffe **N** NE-Metalle
Komplette Träger-Zubehörliste mit Art. Nr. und Preise auf Seite 81.

XNEX 0806.. ECKFRÄSER 90°

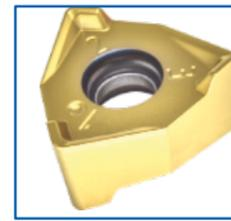

XNEX 080608

Art. Nr.		I.C.	S	r	ap max	
2651321	XNEX 080608-M13 RT330	12,48	6,45	0,8	7,5	6,90 €

P **M**

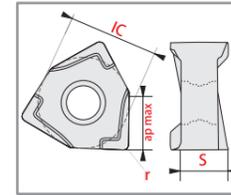

MESSERKOPF MIT IK FÜR XNEX 0806

Art. Nr.		D	d	L	Z	ap max	
SM28524	TK90 XNEX08 D050 A22 Z04-H *	50	22	40	4	7,5	86,00 €
SM28517	TK90 XNEX08 D063 A22 Z05-H *	63	22	40	5	7,5	99,00 €
SM28500	TK90 XNEX08 D080 A27 Z07-H *	80	27	50	7	7,5	118,00 €
SM32316	TK90 XNEX08 D0100 A32 Z08-H *	100	32	50	8	7,5	142,00 €

Wendeschneidplatte (Milling Inserts): XNEX...

* = MIT KÜHLKANÄLEN - WITH COOLING HOLES

Zubehör



SCHRAUBE

SSV M4x12 - 9515 (T15)

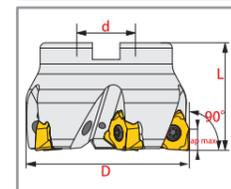

TK90 VCGT ECKFRÄSER 90°

VCGT WENDESCHNEIDPLATTEN



N

Art. Nr.	VCGT...-ALZ RT100	
1771333	VCGT 160402-ALZ RT100	4,40 €
1771334	VCGT 160404-ALZ RT100	4,40 €
1771335	VCGT 160408-ALZ RT100	4,40 €
1771336	VCGT 160412-ALZ RT100	4,40 €
1771337	VCGT 220530-ALZ RT100	5,90 €



VCGT ECKFRÄSER 90°

Art. Nr.		D	d	L	Z	ap max	
SM33849	TK90 VC16 D40 A16 Z03-H *	40	16	40	3	15,5	53,00 €
SM33863	TK90 VC16 D50 A22 Z04-H *	50	22	40	4	15,5	66,00 €
SM33887	TK90 VC16 D63 A22 Z05-H *	63	22	40	5	15,5	79,00 €
SM33924	TK90 VC22 D50 A22 Z04-H *	50	22	50	4	21,5	68,00 €
SM33931	TK90 VC22 D63 A22 Z05-H *	63	22	50	5	21,5	88,00 €
SM33979	TK90 VC22 D80 A27 Z05-H *	80	27	50	5	21,5	102,00 €

Wendeschneidplatte (Milling Inserts): VCGT...

* = MIT KÜHLKANÄLEN - WITH COOLING HOLES

Zubehör



SCHRAUBE

VC16	SSV M3,5x10 - 9511 (T15)
VC22	SSV M5x13 - 9519 (T20)

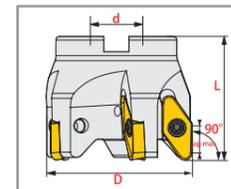

APKT 11 ECKFRÄSER 90°

90° Eckfräsen mit positiv angestellten Wendschneidplatten

APKT 11 WENDESCHNEIDPLATTEN

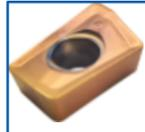

RT250X
(STAHL/EDELSTAHL)

P

M

Art. Nr.	L	D	S	I.W	r	Anwendung	
2651241 APKT 11T304-PM RT250X	12,24	2,8	3,6	6,5	0,4	STAHL/EDELSTAHL	4,40 €
2651242 APKT 11T308-PM RT250X	12,24	2,8	3,6	6,5	0,8	STAHL/EDELSTAHL	4,40 €
2651243 APKT 11T312-PM RT250X	12,24	2,8	3,6	6,5	1,2	STAHL/EDELSTAHL	4,40 €
2651244 APKT 11T316-PM RT250X	12,24	2,8	3,6	6,5	1,6	STAHL/EDELSTAHL	4,40 €
2651245 APKT 11T320-PM RT250X	12,24	2,8	3,6	6,5	2,0	STAHL/EDELSTAHL	4,40 €

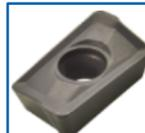

RT150K
(Guss)

K

2651246 APKT 11T304-PM RT150K	12,24	2,8	3,6	6,5	0,4	GUSS	4,40 €
2651247 APKT 11T308-PM RT150K	12,24	2,8	3,6	6,5	0,8	GUSS	4,40 €
2651248 APKT 11T312-PM RT150K	12,24	2,8	3,6	6,5	1,2	GUSS	4,40 €
2651249 APKT 11T316-PM RT150K	12,24	2,8	3,6	6,5	1,6	GUSS	4,40 €
2651250 APKT 11T320-PM RT150K	12,24	2,8	3,6	6,5	2,0	GUSS	4,40 €



RT100
(NE-METALLE)

N

2651251 APKT 11T304-ALZ RT100	12,24	2,8	3,6	6,5	0,4	NE-METALLE	4,40 €
2651252 APKT 11T308-ALZ RT100	12,24	2,8	3,6	6,5	0,8	NE-METALLE	4,40 €

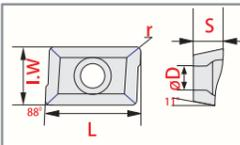

MESSERKOPF MIT IK FÜR APKT 11

Art. Nr.	D	d	L	Z	ap max	
2101241 MK90-AP11-D040-A16 Z05-H	40	16	40	5	10,5	59,00 €
2101242 MK90-AP11-D050-A22 Z06-H	50	22	40	6	10,5	66,00 €
2101243 MK90-AP11-D063-A22 Z07-H	63	22	40	7	10,5	79,00 €
2101244 MK90-AP11-D080-A27 Z10-H	80	27	50	10	10,5	109,00 €

Zubehör



SCHRAUBE
IPM 2,5x6,5T (T08)

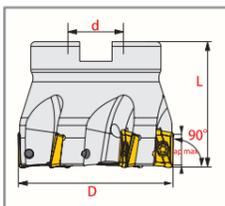

SCHAFTFRÄSER MIT IK FÜR APKT 11

Art. Nr.	D	d	L	L1	Z	ap max	
2101261 SF90-AP11-D12-W16-L85-Z01-H	12	16	85	25	1	10,5	44,00 €
2101262 SF90-AP11-D16-W16-L90-Z02-H	16	16	90	25	2	10,5	55,00 €
2101263 SF90-AP11-D20-W20-L100-Z03-H	20	20	100	30	3	10,5	66,00 €
2101264 SF90-AP11-D25-W25-L115-Z04-H	25	25	115	35	4	10,5	74,00 €
2101265 SF90-AP11-D32-W32-L125-Z04-H	32	32	125	40	4	10,5	86,00 €

Zubehör



SCHRAUBE
IPM 2,5x6,5T (T08)

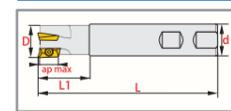

EINSCHRAUBFRÄSER MIT IK FÜR APKT 11

Art. Nr.	D	d	L	I	M	Z	ap max	
SM46344 MT90-APKT11-D16-M08-L25-Z02-H	16	15	25	17	8	2	10,5	79,00 €
SM46351 MT90-APKT11-D20-M10-L30-Z03-H	20	18	30	19	10	3	10,5	89,00 €
SM46368 MT90-APKT11-D25-M12-L35-Z04-H	25	21	35	23	12	4	10,5	99,00 €
2151264 EF90-AP11-D32-M16-L43-Z05	32	29	43		16	5	10,5	114,00 €
2151265 EF90-AP11-D40-M16-L43-Z06	40	29	43		16	6	10,5	119,00 €

Zubehör



SCHRAUBE
SSV M2,5x6 - 9505 (T08)
IPM 2,5x6,5T (T08)

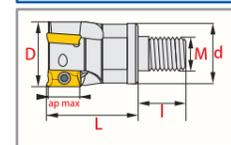

EINSCHRAUBFRÄSER VERLÄNGERUNGEN



Art. Nr.	Einschraubfräser Verlängerung	Ø	Gewinde	Länge	
SM37236	SMVT D15 C16 M08 L120-H	16 mm	M8	120 mm	62,00 €
SM24144	SMVT D18 C20 M10 L170-H	20 mm	M10	170 mm	85,00 €
SM24168	SMVT D24 C25 M12 L160-H	25 mm	M12	160 mm	91,00 €
SM24175	SMVT D24 C25 M12 L200-H	25 mm	M12	200 mm	114,00 €
SM24182	SMVT D24 C25 M12 L250-H	25 mm	M12	250 mm	143,00 €
SM24199	SMVT D31 C32 M16 L160-H	32 mm	M16	160 mm	97,00 €
SM24205	SMVT D31 C32 M16 L200-H	32 mm	M16	200 mm	132,00 €



TK RD 1003../12T3../1604 FORMFRÄSER/MESSERKOPF

Art. Nr.	D	d	L	Z	ap max			
SM28180	TK RD1003 D040 A16 Z04-H	*	40	16	40	4	5	58,40 €
SM50242	TK RD1003 D052 A22 Z05-H	*	52	22	40	5	5	76,80 €
SM50259	TK RD1003 D066 A27 Z06-H	*	66	27	50	6	5	96,80 €
SM28159	TK RD1003 D080 A27 Z07-H	*	80	27	50	7	5	104,80 €
SM28135	TK RD12T3 D040 A16 Z04-H	*	40	16	40	4	6	58,40 €
SM28128	TK RD12T3 D050 A22 Z05-H	*	50	22	40	5	6	70,40 €
SM50266	TK RD12T3 D052 A22 Z05-H	*	52	22	40	5	6	74,40 €
SM28111	TK RD12T3 D063 A22 Z06-H	*	63	22	50	6	6	89,60 €
SM50273	TK RD12T3 D066 A27 Z06-H	*	66	27	50	6	6	96,80 €
SM28104	TK RD12T3 D080 A27 Z07-H	*	80	27	50	7	6	104,80 €
SM33320	TK RD1604 D063 A22 Z05-H	*	63	22	40	5	8	91,20 €
SM33368	TK RD1604 D080 A27 Z06-H	*	80	27	50	6	8	104,80 €

Wendeschneidplatte (Milling Inserts): RD..

* = MIT KÜHLKANÄLEN - WITH COOLING HOLES

Zubehör



SCHRAUBE

RD1003	SSV M3,5x8-SC - 9513 (T10)
RD12T3	SSV M3,5x10 - 9511 (T15)
RD1604	SSV M4,5x11 - 9518 (T20)

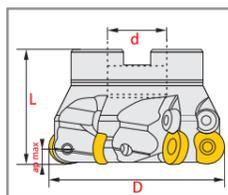

ST RD 1003../12T3.. FORMFRÄSER/SCHAFTFRÄSER

Art. Nr.	D	d	L	l	Z	ap max		
SM13261	ST RD1003 D20 W20 L150 Z02	20	20	150	40	2	5	66,40 €
SM13292	ST RD1003 D20 C20 L200 Z02	20	20	200	50	2	5	80,00 €
SM13360	ST RD12T3 D25 W25 L150 Z02	25	25	150	40	2	6	66,40 €
SM13377	ST RD12T3 D25 C25 L200 Z02	25	25	200	50	2	6	80,00 €
SM13391	ST RD12T3 D32 W32 L150 Z03	32	32	150	40	3	6	72,80 €

Wendeschneidplatte (Milling Inserts): RD..

Zubehör



SCHRAUBE

RD1003	SSV M3,5x8-SC - 9513 (T10)
RD12T3	SSV M3,5x10 - 9511 (T15)

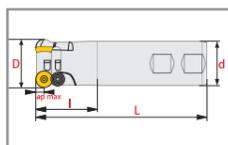

MT RD 1003../12T3.. FORMFRÄSER/EINSCHRAUBFRÄSER

Art. Nr.	D	d1	d2	L	l	M	Z	ap max			
SM15654	MT RD1003 D20 M10 L30 Z02-H	*	20	18	10,5	30	19	10	2	5	66,40 €
SM15661	MT RD1003 D25 M12 L35 Z03-H	*	25	21	12,5	35	23	12	3	5	70,40 €
SM15685	MT RD1003 D32 M16 L43 Z04-H	*	32	29	17	43	23	16	4	5	80,00 €
SM15692	MT RD1003 D35 M16 L43 Z04-H	*	35	29	17	43	23	16	4	5	80,00 €
SM15722	MT RD12T3 D25 M12 L35 Z02-H	*	25	21	12,5	35	23	12	2	6	73,60 €
SM15739	MT RD12T3 D32 M16 L43 Z03-H	*	32	29	17	43	23	16	3	6	80,00 €
SM15746	MT RD12T3 D35 M16 L43 Z03-H	*	35	29	17	43	23	16	3	6	80,00 €
SM15760	MT RD12T3 D42 M16 L43 Z04-H	*	42	29	17	43	23	16	4	6	86,40 €

Wendeschneidplatte (Milling Inserts): RD..

* = MIT KÜHLKANÄLEN - WITH COOLING HOLES

Zubehör



SCHRAUBE

RD1003	SSV M3,5x8-SC - 9513 (T10)
RD12T3	SSV M3,5x10 - 9511 (T15)

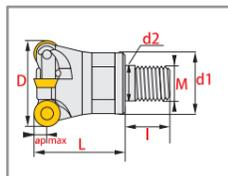

RDHT/RDKW 1003../12T3../1604..



P

Art. Nr.	Stahl	
2651082	RDKW 1003MO RT300	3,90 €
2651084	RDKW 12T3MO RT300	4,20 €
2651086	RDKW 1604MO RT300	5,80 €



N

Art. Nr.	NE-Metalle	
2651062	RDHT 1003MO-ALZ RT100	4,20 €
2651063	RDHT 12T3MO-ALZ RT100	4,40 €
2651064	RDHT 1604MO-ALZ RT100	5,20 €



H

Art. Nr.	Harte Werkstoffe	
2651102	RDKW 1003MO RT105 HART	3,90 €
2651104	RDKW 12T3MO RT105 HART	4,20 €
2651105	RDKW 1604MO RT105 HART	5,90 €



TK RD 10T3../1204.. FORMFRÄSER/MESSERKOPF

Art. Nr.	D	d	L	Z	ap max			
SM32958	TK RD10T3 D040 A16 Z04-H	*	40	16	40	4	5	58,40 €
SM32934	TK RD10T3 D050 A22 Z05-H	*	50	22	40	5	5	70,40 €
SM32941	TK RD10T3 D063 A22 Z06-H	*	63	22	40	6	5	89,60 €
SM32972	TK RD1204 D040 A16 Z04-H	*	40	16	40	4	6	58,40 €
SM32989	TK RD1204 D050 A22 Z05-H	*	50	22	40	5	6	70,40 €
SM33252	TK RD1204 D063 A22 Z06-H	*	63	22	40	5	6	89,60 €
SM33276	TK RD1204 D080 A27 Z07-H	*	80	27	50	7	6	104,80 €

Wendeschneidplatte (Milling Inserts): RD..

* = MIT KÜHLKANÄLEN - WITH COOLING HOLES

Zubehör



SCHRAUBE

RD10T3	SSV M3,5x8-SC - 9513 (T10)
RD1204	SSV M3,5x10 - 9511 (T15)

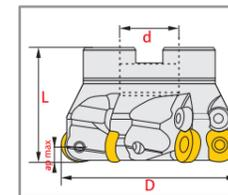

ST RD 0803../1204.. FORMFRÄSER/SCHAFTFRÄSER

Art. Nr.	D	d	L	l	Z	ap max		
SM13124	ST RD0803 D16 W16 L120 Z02	16	16	120	30	2	4	45,60 €
SM13131	ST RD0803 D20 W20 L120 Z02	20	20	120	30	2	4	52,00 €
SM13209	ST RD0803 D20 C20 L200 Z02	20	20	200	50	2	4	80,00 €
SM13148	ST RD0803 D25 W25 L120 Z03	25	25	120	30	3	4	52,00 €
SM13216	ST RD0803 D25 C25 L200 Z03	25	25	200	50	3	4	80,00 €
SM52802	ST RD1204 D25 W25 L150 Z02	25	25	150	40	2	6	66,40 €
SM54462	ST RD1204 D32 W32 L150 Z03	32	32	150	40	3	6	76,80 €

Wendeschneidplatte (Milling Inserts): RD..

Zubehör



SCHRAUBE

RD0803	SSV M3x6 - 9507 (T08)
RD1204	SSV M3,5x10 - 9511 (T15)

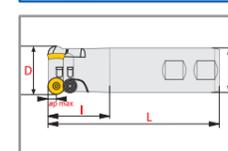

MT RD 0803../10T3../1204.. FORMFRÄSER/EINSCHRAUBFRÄSER

Art. Nr.	D	d1	d2	L	l	M	Z	ap max			
SM25783	MT RD0803 D16 M08 L25 Z02-H	*	16	15	8,5	25	17	8	2	4	80,80 €
SM23970	MT RD0803 D20 M10 L30 Z03-H	*	20	18	10,5	30	19	10	3	4	62,40 €
SM54486	MT RD10T3 D20 M10 L30 Z02-H	*	20	18	10,5	30	19	10	2	5	58,40 €
SM54493	MT RD10T3 D25 M12 L35 Z02-H	*	25	21	12,5	35	23	12	2	5	70,40 €
SM54509	MT RD10T3 D32 M16 L43 Z03-H	*	32	29	17	43	23	16	3	5	76,00 €
SM52819	MT RD1204 D32 M16 L43 Z03-H	*	32	29	17	43	23	16	3	6	80,00 €
SM54516	MT RD1204 D35 M16 L43 Z03-H	*	35	29	17	43	23	16	3	6	80,00 €
SM54523	MT RD1204 D40 M16 L43 Z04-H	*	40	29	17	43	23	16	4	6	82,40 €
SM52826	MT RD1204 D42 M16 L43 Z04-H	*	42	29	17	43	23	16	4	6	86,40 €

Wendeschneidplatte (Milling Inserts): RD..

* = MIT KÜHLKANÄLEN - WITH COOLING HOLES

Zubehör



SCHRAUBE

RD0803	SSV M3x6 - 9507 (T08)
RD10T3 20 MM	SSV M3,5x8 - 9510 (T15)
RD10T3 25 & 32 MM	SSV M3,5x10 - 9511 (T15)
RD1204	SSV M3,5x10 - 9511 (T15)

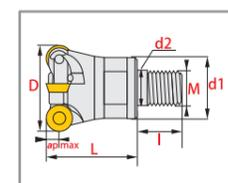

RDHT/RDKW/RDMT 0803../10T3../1204..



P

Art. Nr.	Stahl	
2651087	RDKW 0803MO RT300	3,90 €
2651083	RDKW 10T3MO RT300	3,90 €
2651085	RDKW 1204MO RT300	4,20 €



P M

Art. Nr.	Stahl und Edelstahl	
2651122	RDMT 0803MO RT300	3,90 €
2651124	RDMT 10T3MO RT300	3,90 €
2651126	RDMT 1204MO RT300	4,20 €



H

Art. Nr.	Harte Werkstoffe	
2651103	RDKW 10T3MO RT105 HART	3,90 €

TCMT FASENFRÄSER



P TCMT HF RT250X

Art. Nr.	r	L	I.C.	S	d	
1771231 TCMT 110204-HF RT250X	0,4	11	6,35	2,38	2,8	3,50 €
1771232 TCMT 110208-HF RT250X	0,8	11	6,35	2,38	2,8	3,50 €
1771233 TCMT 16T304-HF RT250X	0,4	16,5	9,525	3,97	4,4	4,40 €
1771234 TCMT 16T308-HF RT250X	0,8	16,5	9,525	3,97	4,4	4,40 €

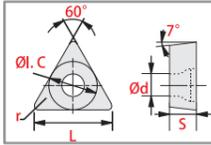

FASENFRÄSER

FASENFRÄSER 25°

Art. Nr.	D1	D2	d	L	l	Z	
SM15463 HF25 TC16 D17-30 W16 L100 Z01	30	17	16	100	30	1	36,00 €

Wendeschneidplatte (Milling Inserts): TCGT/TCMT...

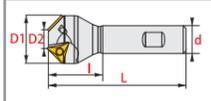

FASENFRÄSER 45°

Art. Nr.	D1	D2	d	L	l	Z	
SM15500 HF45 TCMT11 D4-15 W16 L100 Z01	15	4	16	100	30	1	39,00 €
SM52147 HF45 TCMT16 D5-26 W16 L100 Z01	26	5	16	100	30	1	39,00 €
SM15517 HF45 TCMT16 D10-31 W20 L100 Z02	31	10	20	100	35	2	41,00 €
SM15524 HF45 TCMT16 D14-35 W20 L100 Z02	35	14	20	100	40	2	41,00 €
SM15531 HF45 TCMT16 D22-43 W25 L100 Z03	43	22	25	100	40	3	45,00 €

Wendeschneidplatte (Milling Inserts): TCGT/TCMT...

FASENFRÄSER 62°

Art. Nr.	D1	D2	d	L	l	Z	
SM51690 HF62 TC16 D14-40 W20 L100 Z03	40	14	20	100	40	3	47,20 €

Wendeschneidplatte (Milling Inserts): TCGT/TCMT...

Zubehör



SCHRAUBE

TC11	SSV M2,5x7 - 9506 (T08)
TC16	SSV M3,5x10 - 9511 (T15)

SPMG FASENFRÄSER



P SPMG WEDESCHNEIDPLATTEN

Art. Nr.	SPMG -PM	
3101414 SPMG 090408-PM RT300		6,00 €
3101415 SPMG 110408-PM RT300		6,60 €



FASENFRÄSER HF45° ... SPMG...

Art. Nr.	D1	D2	d	L	l	Z	
SM15555 HF45 SP09 D11-25 W20 L150 Z01	25	11	20	150	30	1	44,00 €
SM15562 HF45 SP11 D24-38 W25 L150 Z02	38	24	25	150	35	2	49,00 €
SM15579 HF45 SP11 D31-45 W32 L150 Z03	45	31	32	150	40	3	49,00 €

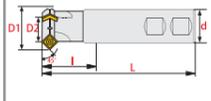

Zubehör



SCHRAUBE

SPMG 09	SSV M3,5x10 - 9511 (T15)
SPMG 11	SSV M4x10 - 9514 (T15)

P Stahl **M** Edelstahl **K** Guss **S** Sonderwerkstoffe **H** Harte Werkstoffe **N** NE-Metalle
 Komplette Träger-Zubehörliste mit Art. Nr. und Preise auf Seite 81.

T-NUTENFRÄSER



TF90 T-NUTENFRÄSER

	D	d	D1	L	l	Z	a	t max	
SM15012 TF90 CC06 D40x12 W25 L120 Z06 T09	40	25	22	120	40	6	12	9	99,00 €
SM15043 TF90 CC06 D45x8 W32 L120 Z06 T10	45	32	25	120	45	6	8	10	114,00 €
SM15050 TF90 CC06 D45x10 W32 L120 Z06 T10	45	32	25	120	45	6	10	10	114,00 €
SM15067 TF90 CC06 D50x8 W32 L120 Z06 T12,5	50	32	25	120	45	6	8	12,5	129,00 €
SM15074 TF90 CC06 D50x10 W32 L120 Z06 T12,5	50	32	25	120	45	6	10	12,5	129,00 €
SM15081 TF90 CC06 D55x8 W32 L120 Z08 T15	55	32	25	120	45	8	8	15	144,00 €
SM15098 TF90 CC06 D55x10 W32 L120 Z08 T15	55	32	25	120	45	8	10	15	144,00 €

Wendeschneidplatte (Milling Inserts): CCGT/CCMT... (siehe unten)

Zubehör



SCHRAUBE

SSV M2,5x7 - 9506 (T08)

TF90 T-NUTENFRÄSER 6 MM SPMG...

	D	d	d1	L	l	Z	a	t max	
2401021 TF90 SP05 D40x06 W16 L120 Z06 T11,5	40	16	15,5	120	25	6	6	11,5	133,00 €
2401022 TF90 SP05 D50x06 W16 L120 Z06 T15,5	50	16	15,5	120	25	6	6	15,5	147,00 €

Wendeschneidplatte (Milling Inserts): SPMG 050204



P

M

Art. Nr. SPMG -PM

3101411 SPMG 050204-PM RT300 **4,70 €**



DKT T-NUTENFRÄSER

	D	d	D1	l	l2	L	a	Z	t max	
SM20672 DKT K3C D50 W20 L120 Z02 T12	50	20	26	70	50	120	3	2	12	167,00 €
SM20702 DKT K3C D63 W25 L120 Z02 T17	63	25	29	65	55	120	3	2	17	189,00 €
SM20689 DKT K4C D50 W20 L120 Z02 T12	50	20	26	70	50	120	4	2	12	167,00 €
SM20719 DKT K4C D63 W25 L120 Z02 T17	63	25	29	65	55	120	4	2	17	189,00 €

Wendeschneidplatte (Milling Inserts): MG../MR..

MG../MR.. Wendeschneidplatten siehe S. 28

Zubehör



SCHRAUBE

D50	BKTV M6x25 - 9215 (SW5)
D63	BKTV M8x28 - 9216 (SW5)

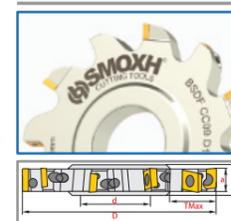

BSDF SCHEIBENFRÄSER

	D	d	a	B	Z	t max	
SM15241 BSDF CC06 D80x8 d27 Z10 T19	80	27	8	12	10	19	147,00 €
SM15296 BSDF CC06 D100x10 d32 Z12 T22,5	100	32	10	14	12	22,5	169,00 €
SM15333 BSDF CC06 D125x10 d40 Z14 T29	125	40	10	14	14	29	199,00 €
SM15388 BSDF CC06 D160x10 d40 Z16 T47,5	160	40	10	14	16	47,5	239,00 €

SM15265 BSDF CC09 D80x12 d27 Z08 T17,5	80	27	12	16	8	17,5	147,00 €
SM15302 BSDF CC09 D100x12 d32 Z10 T22,5	100	32	12	16	10	22,5	169,00 €
SM15340 BSDF CC09 D125x12 d40 Z12 T29	125	40	12	16	12	29	211,00 €
SM15371 BSDF CC09 D160x12 d40 Z14 T45	160	40	12	16	14	45	239,00 €
SM50143 BSDF CC09 D200x12 d40 Z16 T70	200	40	12	16	16	70	292,00 €

SM50167 BSDF CC12 D200x16 d40 Z12 T70 **292,00 €**

Wendeschneidplatte (Milling Inserts): CCGT/CCMT...



P

M

CCMT-HF WEDESCHNEIDPLATTEN

Art. Nr.	CCMT-HF	L	I.C.	S	d	r	
1771431 CCMT 060202-HF RT250X		6,4	6,35	2,38	2,8	0,2	3,30 €
1771432 CCMT 060204-HF RT250X		6,4	6,35	2,38	2,8	0,4	3,30 €
1771433 CCMT 060208-HF RT250X		6,4	6,35	2,38	2,8	0,8	3,30 €
1771434 CCMT 09T302-HF RT250X		9,7	9,525	3,97	4,4	0,2	3,90 €
1771435 CCMT 09T304-HF RT250X		9,7	9,525	3,97	4,4	0,4	3,90 €
1771436 CCMT 09T308-HF RT250X		9,7	9,525	3,97	4,4	0,8	3,90 €
1771437 CCMT 120404-HF RT250X		12,9	12,7	4,76	5,56	0,4	4,50 €
1771438 CCMT 120408-HF RT250X		12,9	12,7	4,76	5,56	0,8	4,50 €

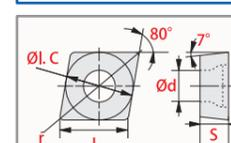

VHM-HPC-FRÄSER

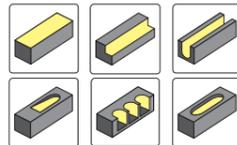

- SPIRALWINKEL 35/38°
- WELDON SCHAFT
- ÜBER MITTE SCHNEIDEND
- SCHRAPPEN UND SCHLICHTEN
- 4 ZÄHNE

Art.Nr.		Länge	D	d(h6)	d1	H	M	L	Z	
2551129	HPC-Z4-D3.0 RT405	STANDARD	3	6	2,7	8	14	57	4	13,50 €
2551121	HPC-Z4-D4.0 RT405	STANDARD	4	6	3,7	11	19	57	4	13,50 €
2551122	HPC-Z4-D5.0 RT405	STANDARD	5	6	4,7	13	21	57	4	13,50 €
2551123	HPC-Z4-D6.0 RT405	STANDARD	6	6	5,7	13	21	57	4	13,50 €
2551124	HPC-Z4-D8.0 RT405	STANDARD	8	8	7,7	19	27	63	4	18,00 €
2551125	HPC-Z4-D10.0 RT405	STANDARD	10	10	9,5	22	32	72	4	25,00 €
2551126	HPC-Z4-D12.0 RT405	STANDARD	12	12	11,5	26	38	83	4	33,00 €
2551127	HPC-Z4-D16.0 RT405	STANDARD	16	16	15,5	32	44	92	4	49,00 €
2551128	HPC-Z4-D20.0 RT405	STANDARD	20	20	19,5	38	54	104	4	74,00 €

Art.Nr.		Länge	D	d(h6)	d1	H	M	L	Z	
2551601	HPCK-Z4-D4.0 RT405	KURZVERSION	4	6	3,7	8	16	54	4	13,50 €
2551602	HPCK-Z4-D5.0 RT405	KURZVERSION	5	6	4,7	9	17	54	4	13,50 €
2551603	HPCK-Z4-D6.0 RT405	KURZVERSION	6	6	5,7	10	18	54	4	13,50 €
2551604	HPCK-Z4-D8.0 RT405	KURZVERSION	8	8	7,7	12	22	58	4	18,00 €
2551605	HPCK-Z4-D10.0 RT405	KURZVERSION	10	10	9,5	14	26	66	4	25,00 €
2551606	HPCK-Z4-D12.0 RT405	KURZVERSION	12	12	11,5	16	28	73	4	33,00 €
2551607	HPCK-Z4-D16.0 RT405	KURZVERSION	16	16	15,5	22	34	82	4	49,00 €
2551608	HPCK-Z4-D20.0 RT405	KURZVERSION	20	20	19,5	26	42	92	4	74,00 €

Art.Nr.		Länge	D	d(h6)	d1	H	M	L	Z	
2551615	HPCL-Z4-D3.0 RT405	LANGVERSION	3	6	2,7	6,5	15	58	4	18,90 €
2551616	HPCL-Z4-D4.0 RT405	LANGVERSION	4	6	3,7	8,5	20	62	4	18,90 €
2551617	HPCL-Z4-D5.0 RT405	LANGVERSION	5	6	4,7	10,5	25	70	4	18,90 €
2551618	HPCL-Z4-D6.0 RT405	LANGVERSION	6	6	5,7	13	30	70	4	18,90 €
2551619	HPCL-Z4-D8.0 RT405	LANGVERSION	8	8	7,7	17	40	80	4	25,40 €
2551620	HPCL-Z4-D10.0 RT405	LANGVERSION	10	10	9,5	21	50	94	4	34,90 €
2551621	HPCL-Z4-D12.0 RT405	LANGVERSION	12	12	11,5	25	60	109	4	47,90 €
2551622	HPCL-Z4-D16.0 RT405	LANGVERSION	16	16	15,5	33	80	132	4	96,00 €
2551623	HPCL-Z4-D20.0 RT405	LANGVERSION	20	20	19,5	55	98	150	4	153,00 €

SCHNITTDATEN HPC-FRÄSER

	Ae	Schnittgeschw. Vc[m/min]	Vorschub fz [mm/z]					
			Ø 3-5	Ø 6-8	Ø 10	Ø 12-16	Ø 20	
Baustahl Einsatzstahl	< 450	1/1	170-200	0,05-0,06	0,06-0,07	0,07	0,07-0,08	0,08
		1/2	190-230	0,07-0,08	0,08-0,09	0,09	0,09-0,1	0,1
		1/10	200-280	0,12-0,14	0,14-0,18	0,22	0,23-0,27	0,32-0,36
Vergütungsstahl	450-700	1/1	130-190	0,05-0,06	0,06-0,07	0,07	0,07-0,08	0,08
		1/2	160-210	0,07-0,08	0,08-0,09	0,09	0,09-0,1	0,1
		1/10	180-220	0,12-0,14	0,14-0,18	0,22	0,23-0,27	0,32-0,36
Werkzeugstahl	> 700	1/1	120-180	0,05-0,06	0,06-0,07	0,07	0,07-0,08	0,08
		1/2	150-200	0,07-0,08	0,08-0,09	0,09	0,09-0,1	0,1
		1/10	170-220	0,12-0,14	0,14-0,18	0,22	0,23-0,27	0,32-0,36
Edelstahl	<1100	1/1	60-90	0,05	0,05	0,05	0,05-0,06	0,06
		1/2	80-100	0,06	0,06-0,07	0,07	0,07-0,08	0,08
		1/10	100-130	0,1	0,1-0,12	0,12	0,14-0,16	0,18
Gusseisen Grauguss Temperguss		1/1	150-200	0,06	0,06-0,07	0,07	0,07-0,08	0,08
		1/2	160-240	0,08	0,09	0,09	0,09-0,10	0,10
		1/10	220-280	0,14-0,16	0,15-0,18	0,22	0,25-0,27	0,36
Gehärteter Stahl bis 55 HRC		1/1	100	0,045	0,045-0,053	0,053	0,053-0,06	0,06
		1/2	120	0,06	0,06-0,07	0,07	0,07-0,08	0,08
		1/10	140	0,1	0,1-0,12	0,12-0,14	0,16	0,18

VHM-HPC-Fräser

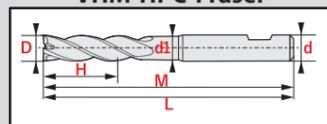

VHM-Schaftfräser

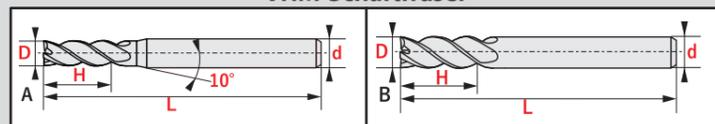

Anwendungen

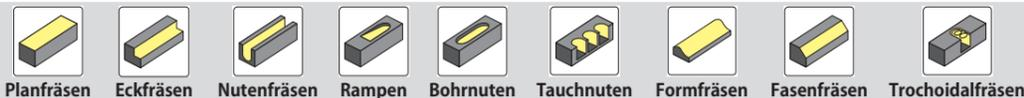

VHM-SCHAFTFRÄSER

VHM-SCHAFTFRÄSER Z=4 - STANDARDLÄNGE

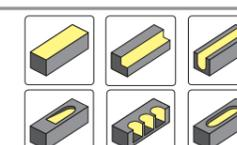

- SPIRALWINKEL 30°
- WELDON SCHAFT
- ÜBER MITTE SCHNEIDEND
- SCHLICHTEN
- 4 ZÄHNE

Art. Nr.		D	d(h6)	H	L	Z	Geom.	
2551211	SF-Z4-D3.0 RT405	3	6	8	57	4	A	12,15 €
2551212	SF-Z4-D4.0 RT405	4	6	11	57	4	A	12,15 €
2551213	SF-Z4-D5.0 RT405	5	6	13	57	4	A	12,15 €
2551214	SF-Z4-D6.0 RT405	6	6	13	57	4	B	12,15 €
2551215	SF-Z4-D8.0 RT405	8	8	19	63	4	B	17,90 €
2551216	SF-Z4-D10.0 RT405	10	10	22	72	4	B	26,30 €
2551217	SF-Z4-D12.0 RT405	12	12	26	83	4	B	32,00 €
2551218	SF-Z4-D14.0 RT405	14	14	26	83	4	B	37,80 €
2551219	SF-Z4-D16.0 RT405	16	16	32	92	4	B	56,00 €
2551220	SF-Z4-D20.0 RT405	20	20	38	104	4	B	88,00 €

VHM-SCHAFTFRÄSER Z=4 - LANGAUSFÜHRUNG

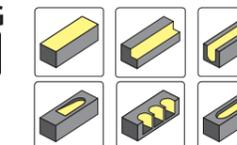

- SPIRALWINKEL 45°
- ZYLINDERSCHAFT
- ÜBER MITTE SCHNEIDEND
- SCHLICHTEN
- 4 ZÄHNE

Art. Nr.		D	d(h6)	H	L	Z	Geom.	
2551231	SFL-Z4-D3.0 RT405	3	6	12	75	4	A	15,00 €
2551232	SFL-Z4-D4.0 RT405	4	6	15	75	4	A	15,00 €
2551233	SFL-Z4-D5.0 RT405	5	6	20	75	4	A	15,00 €
2551234	SFL-Z4-D6.0 RT405	6	6	20	75	4	B	15,00 €
2551235	SFL-Z4-D8.0 RT405	8	8	25	100	4	B	22,90 €
2551236	SFL-Z4-D10.0 RT405	10	10	30	100	4	B	32,40 €
2551237	SFL-Z4-D12.0 RT405	12	12	35	100	4	B	43,80 €
2551238	SFL-Z4-D14.0 RT405	14	14	40	100	4	B	54,90 €
2551239	SFL-Z4-D16.0 RT405	16	16	50	150	4	B	98,00 €
2551240	SFL-Z4-D20.0 RT405	20	20	55	150	4	B	149,00 €

VHM-SCHAFTFRÄSER EXTRA LANGE SCHNEIDE

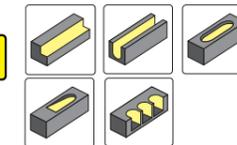

- SPIRALWINKEL 30°
- ZYLINDERSCHAFT
- ÜBER MITTE SCHNEIDEND
- SCHLICHTEN
- 4 ZÄHNE

Art. Nr.		D	d(h6)	H	L	Z	Geom.	
2551021	SFX-Z4-D3.0 RT405	3	6	20	75	4	A	17,50 €
2551022	SFX-Z4-D4.0 RT405	4	6	25	75	4	A	17,50 €
2551023	SFX-Z4-D5.0 RT405	5	6	30	75	4	A	17,50 €
2551024	SFX-Z4-D6.0 RT405	6	6	30	75	4	B	17,50 €
2551025	SFX-Z4-D8.0 RT405	8	8	40	100	4	B	24,90 €
2551026	SFX-Z4-D10.0 RT405	10	10	50	110	4	B	37,20 €
2551027	SFX-Z4-D12.0 RT405	12	12	50	110	4	B	47,50 €
2551028	SFX-Z4-D16.0 RT405	16	16	70	150	4	B	104,00 €
2551029	SFX-Z4-D20.0 RT405	20	20	75	150	4	B	158,60 €

VHM-SCHAFTFRÄSER Z=6



- SPIRALWINKEL 45°
- ZYLINDERSCHAFT
- NICHT ÜBER MITTE SCHNEIDEND
- SCHLICHTEN
- 6 ZÄHNE

Art. Nr.		D	d(h6)	H	L	Z	
2551001	SF-Z6-D6.0 RT405	6	6	18	60	6	21,90 €
2551002	SF-Z6-D8.0 RT405	8	8	20	60	6	28,50 €
2551003	SF-Z6-D10.0 RT405	10	10	30	75	6	38,40 €
2551004	SF-Z6-D12.0 RT405	12	12	32	75	6	45,90 €
2551005	SF-Z6-D16.0 RT405	16	16	40	100	6	84,50 €
2551006	SF-Z6-D20.0 RT405	20	20	45	100	6	129,90 €

VHM-UNTERMASSEFRÄSER



P M
K

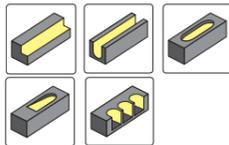

- SPIRALWINKEL 30°
- WELDON SCHAFT
- ÜBER MITTE SCHNEIDEND
- MITTLERE BEARBEITUNG
- 2 ZÄHNE

Art. Nr.	VHM-UNTERMASSEFRÄSER	D	d(h6)	H	L	KCH	CHW	Z	
2551251	VHM-UNTERMASSEFRÄSER-2,8 RT303	2,8	6	7	57	0	0	2	11,00 €
2551252	VHM-UNTERMASSEFRÄSER-3,8 RT303	3,8	6	8	57	0	0	2	11,00 €
2551253	VHM-UNTERMASSEFRÄSER-4,8 RT303	4,8	6	8	57	0	0	2	11,00 €
2551254	VHM-UNTERMASSEFRÄSER-5,75 RT303	5,75	6	10	57	0	0	2	11,00 €
2551255	VHM-UNTERMASSEFRÄSER-7,75 RT303	7,75	8	16	63	45	0,10	2	15,00 €
2551256	VHM-UNTERMASSEFRÄSER-8,7 RT303	8,7	10	16	72	45	0,10	2	22,00 €
2551257	VHM-UNTERMASSEFRÄSER-11,7 RT303	11,7	12	22	83	45	0,10	2	29,00 €
2551258	VHM-UNTERMASSEFRÄSER-13,7 RT303	13,7	14	22	83	45	0,10	2	38,90 €
2551259	VHM-UNTERMASSEFRÄSER-15,7 RT303	15,7	16	26	92	45	0,15	2	47,50 €

VHM TORUSFRÄSER AB ECKENRADIUS 0,2 MM

VHM TORUSFRÄSER STANDARDLÄNGE



P M
K

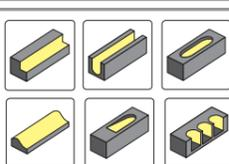

- SPIRALWINKEL 30°
- ZYLINDERSCHAFT
- ÜBER MITTE SCHNEIDEND
- 4 ZÄHNE

Art. Nr.	TFR-Z4	D	r	d(h6)	H	L	Z	Geom.	
2551401	TFR-Z4-D3.0-R0.2 RT405	3	0,2	6	8	50	4	A	16,50 €
2551402	TFR-Z4-D4.0-R0.3 RT405	4	0,3	6	10	50	4	A	16,50 €
2551403	TFR-Z4-D4.0-R0.5 RT405	4	0,5	6	10	50	4	A	16,50 €
2551404	TFR-Z4-D5.0-R0.5 RT405	5	0,5	6	13	50	4	A	18,90 €
2551405	TFR-Z4-D5.0-R1.0 RT405	5	1	6	13	50	4	A	18,90 €
2551406	TFR-Z4-D6.0-R0.5 RT405	6	0,5	6	16	50	4	B	18,90 €
2551407	TFR-Z4-D6.0-R1.0 RT405	6	1	6	16	50	4	B	18,90 €
2551408	TFR-Z4-D8.0-R0.5 RT405	8	0,5	8	20	60	4	B	25,90 €
2551409	TFR-Z4-D8.0-R1.0 RT405	8	1	8	20	60	4	B	25,90 €
2551410	TFR-Z4-D10.0-R0.5 RT405	10	0,5	10	25	75	4	B	35,90 €
2551411	TFR-Z4-D10.0-R1.0 RT405	10	1	10	25	75	4	B	35,90 €
2551412	TFR-Z4-D10.0-R2.0 RT405	10	2	10	25	75	4	B	35,90 €
2551413	TFR-Z4-D10.0-R3.0 RT405	10	3	10	25	75	4	B	35,90 €
2551414	TFR-Z4-D12.0-R0.5 RT405	12	0,5	12	30	75	4	B	44,90 €
2551415	TFR-Z4-D12.0-R1.0 RT405	12	1	12	30	75	4	B	44,90 €
2551416	TFR-Z4-D12.0-R2.0 RT405	12	2	12	30	75	4	B	44,90 €
2551417	TFR-Z4-D12.0-R3.0 RT405	12	3	12	30	75	4	B	44,90 €

VHM TORUSFRÄSER LANGAUSFÜHRUNG



P M
K

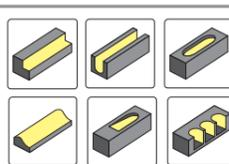

- SPIRALWINKEL 30°
- ZYLINDERSCHAFT
- ÜBER MITTE SCHNEIDEND
- 4 ZÄHNE

Art. Nr.	TFRL-Z4	D	r	d(h6)	H	L	Z	Geom.	
2551431	TFRL-Z4-D6.0-R0.5 RT405	6	0,5	6	16	75	4	B	19,90 €
2551432	TFRL-Z4-D6.0-R1.0 RT405	6	1	6	16	75	4	B	19,90 €
2551433	TFRL-Z4-D8.0-R0.5 RT405	8	0,5	8	20	100	4	B	31,50 €
2551434	TFRL-Z4-D8.0-R1.0 RT405	8	1	8	20	100	4	B	31,50 €
2551435	TFRL-Z4-D10.0-R0.5 RT405	10	0,5	10	25	100	4	B	41,90 €
2551436	TFRL-Z4-D10.0-R1.0 RT405	10	1	10	25	100	4	B	41,90 €
2551437	TFRL-Z4-D10.0-R2.0 RT405	10	2	10	25	100	4	B	41,90 €
2551438	TFRL-Z4-D12.0-R0.5 RT405	12	0,5	12	30	100	4	B	55,90 €
2551439	TFRL-Z4-D12.0-R1.0 RT405	12	1	12	30	100	4	B	55,90 €
2551440	TFRL-Z4-D12.0-R2.0 RT405	12	2	12	30	100	4	B	53,90 €
2551441	TFRL-Z4-D16.0-R1.0 RT405	16	1	16	45	150	4	B	117,90 €
2551442	TFRL-Z4-D16.0-R2.0 RT405	16	2	16	45	150	4	B	117,90 €

VHM-Untermassfräser

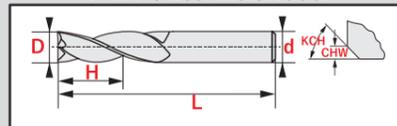

VHM-Torusfräser

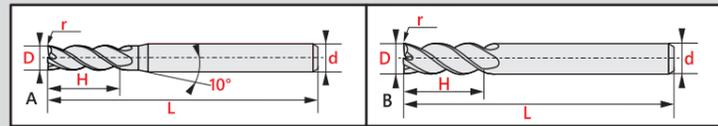

VHM-KUGELFRÄSER

VHM-KUGELFRÄSER Z=2 STANDARDLÄNGE



P M
K

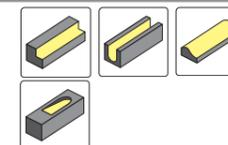

- SPIRALWINKEL 30°
- ZYLINDERSCHAFT
- ÜBER MITTE SCHNEIDEND
- SCHLICHTEN
- 2 ZÄHNE

Art. Nr.	KF-Z2	D	r	d(h6)	H	L	Z	
2551171	KF-Z2-D3.0 RT303	3	1,5	6	4	57	2	11,50 €
2551172	KF-Z2-D4.0 RT303	4	2	6	5	57	2	11,50 €
2551173	KF-Z2-D5.0 RT303	5	2,5	6	6	57	2	11,50 €
2551174	KF-Z2-D6.0 RT303	6	3	6	7	57	2	12,00 €
2551175	KF-Z2-D8.0 RT303	8	4	8	9	63	2	14,50 €
2551176	KF-Z2-D10.0 RT303	10	5	10	11	72	2	21,00 €
2551177	KF-Z2-D12.0 RT303	12	6	12	12	83	2	29,50 €
2551178	KF-Z2-D16.0 RT303	16	8	16	16	92	2	44,00 €
2551179	KF-Z2-D20.0 RT303	20	10	20	20	104	2	74,00 €

VHM-KUGELFRÄSER Z=2 LANGVERSION



P M
K

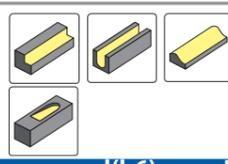

- SPIRALWINKEL 30°
- ZYLINDERSCHAFT
- ÜBER MITTE SCHNEIDEND
- SCHLICHTEN
- 2 ZÄHNE

Art. Nr.	KFL-Z2	D	r	d(h6)	H	L	Z	
2551191	KFL-Z2-D3.0 RT303	3	1,5	6	4	75	2	12,50 €
2551192	KFL-Z2-D4.0 RT303	4	2	6	5	75	2	12,50 €
2551193	KFL-Z2-D5.0 RT303	5	2,5	6	6	80	2	12,90 €
2551194	KFL-Z2-D6.0 RT303	6	3	6	7	80	2	12,90 €
2551195	KFL-Z2-D8.0 RT303	8	4	8	9	90	2	17,00 €
2551196	KFL-Z2-D10.0 RT303	10	5	10	11	100	2	23,90 €
2551197	KFL-Z2-D12.0 RT303	12	6	12	12	120	2	36,00 €

VHM-KUGELFRÄSER Z=4 STANDARDLÄNGE



P M
K

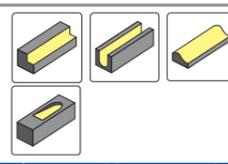

- SPIRALWINKEL 30°
- ZYLINDERSCHAFT
- ÜBER MITTE SCHNEIDEND
- MITTLERE BEARBEITUNG, SCHLICHTEN
- 4 ZÄHNE

Art. Nr.	KF-Z4	D	r	d(h6)	H	L	Z	Geom.	
2551461	KF-Z4-D3.0 RT405	3	1,5	6	6	50	4	A	13,90 €
2551462	KF-Z4-D4.0 RT405	4	2	6	8	50	4	A	13,90 €
2551463	KF-Z4-D5.0 RT405	5	2,5	6	10	50	4	A	13,90 €
2551464	KF-Z4-D6.0 RT405	6	3	6	12	50	4	B	13,90 €
2551465	KF-Z4-D8.0 RT405	8	4	8	16	60	4	B	21,50 €
2551466	KF-Z4-D10.0 RT405	10	5	10	20	75	4	B	29,90 €
2551467	KF-Z4-D12.0 RT405	12	6	12	24	75	4	B	39,50 €
2551468	KF-Z4-D14.0 RT405	14	7	14	28	75	4	B	51,90 €
2551469	KF-Z4-D16.0 RT405	16	8	16	32	100	4	B	71,90 €
2551470	KF-Z4-D18.0 RT405	18	9	18	36	100	4	B	89,90 €
2551471	KF-Z4-D20.0 RT405	20	10	20	40	100	4	B	99,90 €

VHM-KUGELFRÄSER Z=4 LANGVERSION



P M
K

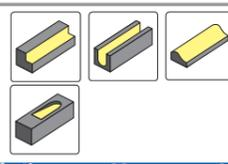

- SPIRALWINKEL 30°
- ZYLINDERSCHAFT
- ÜBER MITTE SCHNEIDEND
- MITTLERE BEARBEITUNG, SCHLICHTEN
- 4 ZÄHNE

Art. Nr.	KFL-Z4	D	r	d(h6)	H	L	Z	Geom.	
2551491	KFL-Z4-D3.0 RT405	3	1,5	6	6	75	4	A	17,50 €
2551492	KFL-Z4-D4.0 RT405	4	2	6	8	75	4	A	17,50 €
2551493	KFL-Z4-D5.0 RT405	5	2,5	6	10	75	4	A	17,50 €
2551494	KFL-Z4-D6.0 RT405	6	3	6	12	75	4	B	17,50 €
2551495	KFL-Z4-D8.0 RT405	8	4	8	16	100	4	B	26,90 €
2551496	KFL-Z4-D10.0 RT405	10	5	10	20	100	4	B	36,90 €
2551497	KFL-Z4-D12.0 RT405	12	6	12	24	100	4	B	43,90 €
2551498	KFL-Z4-D14.0 RT405	14	7	14	28	100	4	B	55,90 €
2551499	KFL-Z4-D16.0 RT405	16	8	16	32	150	4	B	97,00 €
2551500	KFL-Z4-D20.0 RT405	20	10	20	40	150	4	B	147,60 €

VHM-Kugelfräser Z=2

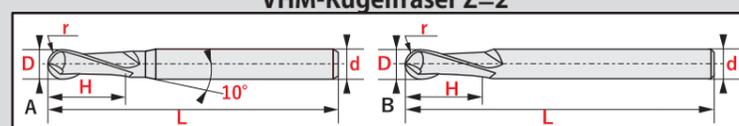

VHM-Kugelfräser Z=4

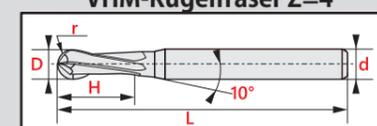

VHM-ENTGRATFRÄSER

VHM FASENFRÄSER 60°



- SPITZENWINKEL 60°
- WELDON SCHAFT

Art. Nr.		d(h6)	L	D	Schaft	X	Z	
2551681	FF-Z3-60-D3.0 RT303	3	48	0,2	HA	60°	3	11,50 €
2551682	FF-Z4-60-D4.0 RT303	4	48	0,2	HA	60°	4	11,50 €
2551683	FF-Z4-60-D6.0 RT303	6	55	0,2	HB	60°	4	13,50 €
2551684	FF-Z4-60-D8.0 RT303	8	58	0,5	HB	60°	4	19,40 €
2551685	FF-Z4-60-D10.0 RT303	10	65	0,5	HB	60°	4	26,70 €
2551686	FF-Z6-60-D10.0 RT303	10	65	0,7	HB	60°	6	36,50 €
2551687	FF-Z4-60-D12.0 RT303	12	75	0,5	HB	60°	4	36,50 €
2551688	FF-Z6-60-D12.0 RT303	12	75	0,7	HB	60°	6	56,00 €
2551689	FF-Z4-60-D16.0 RT303	16	85	0,7	HB	60°	4	79,00 €
2551690	FF-Z6-60-D16.0 RT303	16	85	0,7	HB	60°	6	99,00 €

VHM FASENFRÄSER 90°



- SPITZENWINKEL 90°
- WELDON SCHAFT

Art. Nr.		d(h6)	L	D	Schaft	X	Z	
2551081	FF-Z3-90-D3.0 RT303	3	48	0,2	HA	90°	3	11,50 €
2551082	FF-Z4-90-D4.0 RT303	4	48	0,2	HA	90°	4	11,50 €
2551083	FF-Z4-90-D6.0 RT303	6	55	0,2	HB	90°	4	13,50 €
2551084	FF-Z4-90-D8.0 RT303	8	58	0,5	HB	90°	4	19,40 €
2551085	FF-Z4-90-D10.0 RT303	10	65	0,5	HB	90°	4	26,70 €
2551086	FF-Z4-90-D12.0 RT303	12	75	0,5	HB	90°	4	36,90 €
2551087	FF-Z4-90-D16.0 RT303	16	85	0,7	HB	90°	4	69,00 €

VHM FASENFRÄSER 120°



- SPITZENWINKEL 120°
- WELDON SCHAFT

Art. Nr.		d(h6)	L	D	Schaft	X	Z	
2551101	FF-Z3-120-D3.0 RT303	3	48	0,2	HA	120°	3	11,50 €
2551102	FF-Z4-120-D4.0 RT303	4	48	0,2	HA	120°	4	11,50 €
2551103	FF-Z4-120-D6.0 RT303	6	55	0,2	HB	120°	4	13,50 €
2551104	FF-Z4-120-D8.0 RT303	8	58	0,5	HB	120°	4	19,40 €
2551105	FF-Z4-120-D10.0 RT303	10	65	0,5	HB	120°	4	26,70 €
2551106	FF-Z4-120-D12.0 RT303	12	75	0,5	HB	120°	4	36,90 €
2551107	FF-Z4-120-D16.0 RT303	16	85	0,7	HB	120°	4	69,00 €

VHM-VIERTELKREISFRÄSER - TIALN -



- SPIRALWINKEL 90°
- WELDON SCHAFT

Art. Nr.		d(h6)	L	D	r	Z	
2551561	VKF-Z4-D6.0-R0.2 RT303	6	60	5,6	0,2	4	18,50 €
2551562	VKF-Z4-D6.0-R0.3 RT303	6	60	5,4	0,3	4	18,50 €
2551563	VKF-Z4-D6.0-R0.4 RT303	6	60	5,2	0,4	4	18,50 €
2551564	VKF-Z4-D8.0-R0.5 RT303	8	70	7	0,5	4	29,90 €
2551565	VKF-Z4-D8.0-R0.6 RT303	8	70	6,8	0,6	4	29,90 €
2551566	VKF-Z4-D8.0-R0.75 RT303	8	70	6,5	0,75	4	29,90 €
2551567	VKF-Z4-D8.0-R0.8 RT303	8	70	6,4	0,8	4	29,90 €
2551568	VKF-Z4-D8.0-R1.0 RT303	8	70	6	1	4	29,90 €
2551569	VKF-Z4-D10.0-R1.5 RT303	10	75	7	1,5	4	42,90 €
2551570	VKF-Z4-D10.0-R2.0 RT303	10	75	6	2	4	42,90 €
2551571	VKF-Z4-D12.0-R2.5 RT303	12	75	7	2,5	4	56,90 €
2551572	VKF-Z4-D12.0-R3.0 RT303	12	75	6	3	4	56,90 €
2551573	VKF-Z4-D16.0-R4.0 RT303	16	80	8	4	4	103,90 €
2551574	VKF-Z4-D20.0-R5.0 RT303	20	80	10	5	4	139,00 €

VHM-Fasenfräser



VHM-Viertelkreisfräser

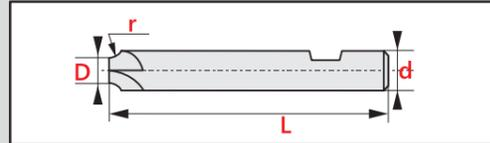

VHM-ALU-SCHAFTFRÄSER

VHM-ALU-SCHAFTFRÄSER Z=1

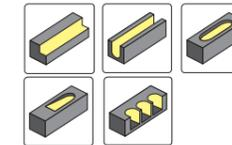

- SPIRALWINKEL 30°
- ÜBER MITTE SCHNEIDEND
- ZYLINDERSCHAFT
- 1 ZAHN

Art. Nr.		D	d(h5)	H	L	Z	
2551581	AF-Z1-D2.0 RT30K	2	3	8	50	1	9,70 €
2551582	AF-Z1-D3.0 RT30K	3	3	12	50	1	9,90 €
2551583	AF-Z1-D4.0 RT30K	4	4	15	60	1	11,30 €
2551584	AF-Z1-D5.0 RT30K	5	5	17	60	1	11,50 €
2551585	AF-Z1-D6.0 RT30K	6	6	20	65	1	12,90 €
2551586	AF-Z1-D8.0 RT30K	8	8	22	65	1	19,30 €
2551587	AF-Z1-D10.0 RT30K	10	10	25	75	1	33,00 €
2551588	AF-Z1-D12.0 RT30K	12	12	30	80	1	44,00 €

VHM-ALU-SCHAFTFRÄSER Z=2 STANDARDLÄNGE

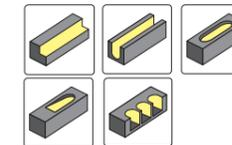

- SPIRALWINKEL 30°
- ÜBER MITTE SCHNEIDEND
- ZYLINDERSCHAFT
- 2 ZÄHNE

Art. Nr.		D	d(h6)	H	L	Z	Geom.	
2551521	AF-Z2-D1.0 RT30K	1	4	3	50	2	A	8,50 €
2551522	AF-Z2-D1.5 RT30K	1,5	4	4	50	2	A	8,50 €
2551523	AF-Z2-D2.0 RT30K	2	4	6	50	2	A	8,50 €
2551524	AF-Z2-D2.5 RT30K	2,5	4	7	50	2	A	8,50 €
2551525	AF-Z2-D3.0 RT30K	3	6	9	50	2	A	10,90 €
2551526	AF-Z2-D4.0 RT30K	4	6	12	50	2	A	10,90 €
2551527	AF-Z2-D5.0 RT30K	5	6	15	50	2	A	10,90 €
2551528	AF-Z2-D6.0 RT30K	6	6	18	60	2	B	10,90 €
2551529	AF-Z2-D8.0 RT30K	8	8	20	60	2	B	16,90 €
2551530	AF-Z2-D10.0 RT30K	10	10	30	75	2	B	29,90 €
2551531	AF-Z2-D12.0 RT30K	12	12	32	75	2	B	36,00 €
2551532	AF-Z2-D16.0 RT30K	16	16	45	100	2	B	64,00 €
2551533	AF-Z2-D20.0 RT30K	20	20	45	100	2	B	94,00 €

VHM-ALU-SCHAFTFRÄSER Z=2 LÄNGVERSION

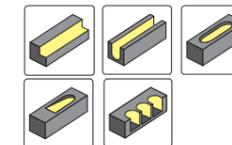

- SPIRALWINKEL 45°
- ÜBER MITTE SCHNEIDEND
- ZYLINDERSCHAFT
- 2 ZÄHNE

Art. Nr.		D	d(h6)	H	L	Z	Geom.	
2551541	AFL-Z2-D3.0 RT30K	3	6	12	60	2	A	11,90 €
2551542	AFL-Z2-D4.0 RT30K	4	6	16	60	2	A	11,90 €
2551543	AFL-Z2-D5.0 RT30K	5	6	20	60	2	A	11,90 €
2551544	AFL-Z2-D6.0 RT30K	6	6	25	75	2	B	14,90 €
2551545	AFL-Z2-D8.0 RT30K	8	8	32	75	2	B	24,90 €
2551546	AFL-Z2-D10.0 RT30K	10	10	45	100	2	B	33,90 €
2551547	AFL-Z2-D12.0 RT30K	12	12	45	100	2	B	41,90 €
2551548	AFL-Z2-D16.0 RT30K	16	16	65	150	2	B	92,90 €
2551549	AFL-Z2-D20.0 RT30K	20	20	75	150	2	B	148,90 €

VHM-Schaftfräser Z=1



VHM-Schaftfräser Z=2

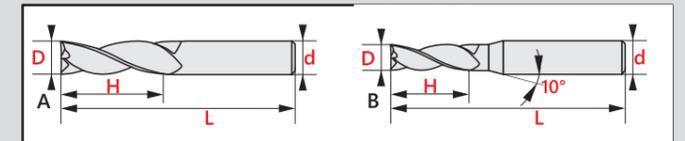

Anwendungen



VHM-ALU-SCHAFTFRÄSER

VHM-ALU-SCHAFTFRÄSER Z=3 - STANDARDLÄNGE

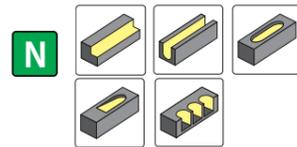

- SPIRALWINKEL 30°
- ÜBER MITTE SCHNEIDEND
- ZYLINDERSCHAFT
- 3 ZÄHNE

Art. Nr.	D	d(h6)	H	L	Z	Geom.	
2551041	AF-Z3-D2.0 RT30K	2	4	6	50	3	A 9,50 €
2551042	AF-Z3-D3.0 RT30K	3	6	9	50	3	A 10,90 €
2551043	AF-Z3-D4.0 RT30K	4	6	12	50	3	A 10,90 €
2551044	AF-Z3-D5.0 RT30K	5	6	15	50	3	A 10,90 €
2551045	AF-Z3-D6.0 RT30K	6	6	18	60	3	B 12,70 €
2551046	AF-Z3-D8.0 RT30K	8	8	20	60	3	B 17,90 €
2551047	AF-Z3-D10.0 RT30K	10	10	30	75	3	B 29,90 €
2551048	AF-Z3-D12.0 RT30K	12	12	32	75	3	B 37,90 €
2551049	AF-Z3-D16.0 RT30K	16	16	45	100	3	B 79,00 €
2351050	AF-Z3-D20.0 RT30K	20	20	45	100	3	B 144,00 €

VHM-ALU-SCHAFTFRÄSER Z=3 - LANGAUSFÜHRUNG

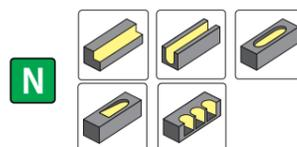

- SPIRALWINKEL 45°
- ÜBER MITTE SCHNEIDEND
- ZYLINDERSCHAFT
- 3 ZÄHNE

Art. Nr.	D	d(h6)	H	L	Z	Geom.	
2551061	AFL-Z3-D3.0 RT30K	3	6	12	60	3	A 12,90 €
2551062	AFL-Z3-D4.0 RT30K	4	6	16	60	3	A 12,90 €
2551063	AFL-Z3-D5.0 RT30K	5	6	20	60	3	A 12,90 €
2551064	AFL-Z3-D6.0 RT30K	6	6	25	75	3	B 15,90 €
2551065	AFL-Z3-D8.0 RT30K	8	8	32	75	3	B 26,50 €
2551066	AFL-Z3-D10.0 RT30K	10	10	45	100	3	B 34,50 €
2551067	AFL-Z3-D12.0 RT30K	12	12	45	100	3	B 44,90 €
2551068	AFL-Z3-D16.0 RT30K	16	16	65	150	3	B 96,90 €
2551069	AFL-Z3-D20.0 RT30K	20	20	75	150	3	B 156,90 €

VHM-ALU-SCHRUPPFÄSER 3 ZÄHNE

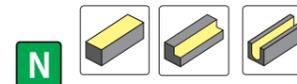

- SPIRALWINKEL 30°
- ÜBER MITTE SCHNEIDEND
- SCHRUPPEN
- ZYLINDERSCHAFT
- 3 ZÄHNE

Art. Nr.	D	d(h6)	H	L	Eckfase	
2551841	AFR-Z3-D6.0 RT30K	6,0	6	16	57	0,60 23,90 €
2551842	AFR-Z3-D7.0 RT30K	7,0	8	16	63	0,60 25,90 €
2551843	AFR-Z3-D8.0 RT30K	8,0	8	16	63	0,60 25,90 €
2551844	AFR-Z3-D9.0 RT30K	9,0	10	19	72	0,60 41,60 €
2551845	AFR-Z3-D10.0 RT30K	10,0	10	22	72	0,60 41,60 €
2551846	AFR-Z3-D12.0 RT30K	12,0	12	26	83	0,60 51,50 €
2551847	AFR-Z3-D14.0 RT30K	14,0	14	26	83	0,91 63,90 €
2551848	AFR-Z3-D16.0 RT30K	16,0	16	32	92	0,91 85,80 €
2551849	AFR-Z3-D18.0 RT30K	18,0	18	32	92	0,91 109,90 €
2551850	AFR-Z3-D20.0 RT30K	20,0	20	38	104	0,91 133,90 €
2551851	AFR-Z3-D25.0 RT30K	25,0	25	45	121	0,91 232,90 €

VHM-ALU-Schrupfräser

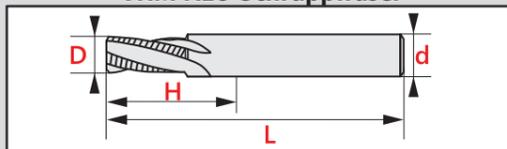

VHM-ALU-Schaftfräser

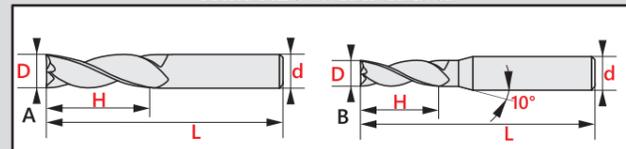

P Stahl **M** Edelstahl **K** Guss **S** Sonderwerkstoffe **H** Harte Werkstoffe **N** NE-Metalle

Komplette Träger-Zubehörliste mit Art. Nr. und Preise auf Seite 81.

VHM-ALU-KUGELFRÄSER

VHM-ALU-KUGELFRÄSER Z=2 - STANDARDLÄNGE

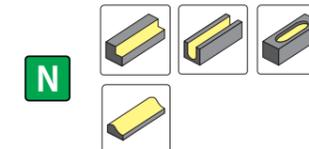

- SPIRALWINKEL 30°
- ÜBER MITTE SCHNEIDEND
- ZYLINDERSCHAFT
- 2 ZÄHNE

Art. Nr.	D	r	d(h6)	d1	H	M	L	Z	
2551271	AKF-Z2-D3.0 RT30K	3	1,5	6	2,8	6	9	57	2 17,00 €
2551272	AKF-Z2-D4.0 RT30K	4	2	6	3,7	8	12	57	2 17,00 €
2551273	AKF-Z2-D5.0 RT30K	5	2,5	6	4,6	10	15	57	2 17,00 €
2551274	AKF-Z2-D6.0 RT30K	6	3	6	5,5	12	20	57	2 17,00 €
2551275	AKF-Z2-D8.0 RT30K	8	4	8	7,4	16	26	63	2 21,90 €
2551276	AKF-Z2-D10.0 RT30K	10	5	10	9,2	20	31	72	2 29,90 €
2551277	AKF-Z2-D12.0 RT30K	12	6	12	11	24	37	83	2 38,90 €
2551278	AKF-Z2-D16.0 RT30K	16	8	16	15	32	43	92	2 64,90 €

VHM-ALU-KUGELFRÄSER Z=2 - LÄNGVERSION

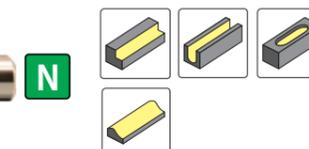

- SPIRALWINKEL 30°
- ÜBER MITTE SCHNEIDEND
- ZYLINDERSCHAFT
- 2 ZÄHNE

Art. Nr.	D	r	d(h6)	d1	H	M	L	Z	
2551291	AKFL-Z2-D3.0 RT30K	3	1,5	6	2,8	6	9	75	2 19,00 €
2551292	AKFL-Z2-D4.0 RT30K	4	2	6	3,7	8	12	75	2 19,00 €
2551293	AKFL-Z2-D5.0 RT30K	5	2,5	6	4,6	10	15	80	2 19,90 €
2551294	AKFL-Z2-D6.0 RT30K	6	3	6	5,5	12	20	80	2 19,90 €
2551295	AKFL-Z2-D8.0 RT30K	8	4	8	7,4	16	26	90	2 23,90 €
2551296	AKFL-Z2-D10.0 RT30K	10	5	10	9,2	20	31	100	2 34,90 €
2551297	AKFL-Z2-D12.0 RT30K	12	6	12	11	24	37	120	2 49,90 €
2551298	AKFL-Z2-D16.0 RT30K	16	8	16	15	32	43	140	2 79,90 €

VHM-ALU-Kugelfräser

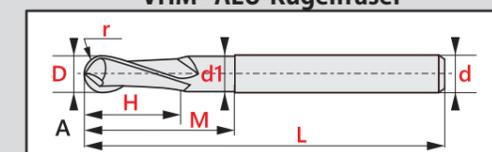

Anwendungen



DLC: HIGH PERFORMANCE IN ALU

DLC = Diamond Like Carbon
Extrem harte und glatte Beschichtung für optimalen Verschleißschutz bei der ALU-Bearbeitung

VHM-ALU-SCHAFTFRÄSER 3 ZÄHNE (DLC BESCHICHTET)

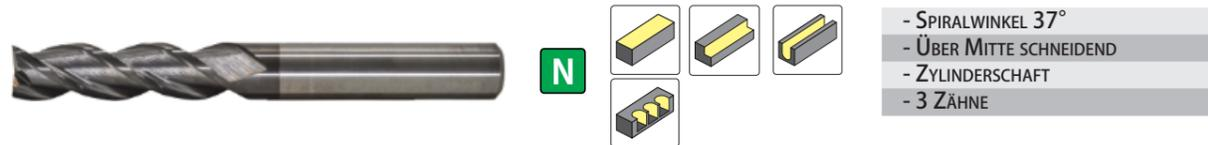

- SPIRALWINKEL 37°
- ÜBER MITTE SCHNEIDEND
- ZYLINDERSCHAFT
- 3 ZÄHNE

Art. Nr.	D	d(h5)	H	L		
2551781	AF-Z3-D3.0 RT107	3,0	6	8	52	15,60 €
2551782	AF-Z3-D4.0 RT107	4,0	6	11	55	20,60 €
2551783	AF-Z3-D5.0 RT107	5,0	6	13	57	20,60 €
2551784	AF-Z3-D6.0 RT107	6,0	6	13	57	20,60 €
2551785	AF-Z3-D8.0 RT107	8,0	8	19	63	32,50 €
2551786	AF-Z3-D10.0 RT107	10,0	10	22	72	47,80 €
2551787	AF-Z3-D12.0 RT107	12,0	12	26	83	66,70 €
2551788	AF-Z3-D16.0 RT107	16,0	16	32	92	113,90 €
2551789	AF-Z3-D20.0 RT107	20,0	20	38	104	183,60 €

VHM-ALU-SCHAFTFRÄSER 3 ZÄHNE LANGVERSION (DLC BESCHICHTET)

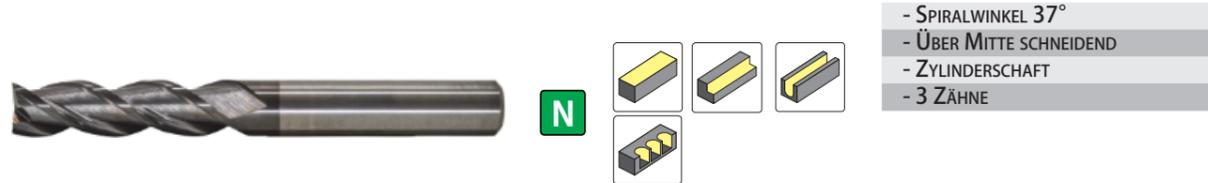

- SPIRALWINKEL 37°
- ÜBER MITTE SCHNEIDEND
- ZYLINDERSCHAFT
- 3 ZÄHNE

Art. Nr.	D	d(h5)	H	L		
2551801	AFL-Z3-D6.0 RT107	6	6	24	75	27,60 €
2551802	AFL-Z3-D8.0 RT107	8	8	32	75	39,90 €
2551803	AFL-Z3-D10.0 RT107	10	10	40	100	60,80 €
2551804	AFL-Z3-D12.0 RT107	12	12	48	100	89,90 €
2551805	AFL-Z3-D16.0 RT107	16	16	64	125	134,90 €
2551806	AFL-Z3-D20.0 RT107	20	20	80	150	224,90 €
2551807	AFL-Z3-D25.0 RT107	25	25	50	125	279,90 €

VHM-DLC- Schaftfräser

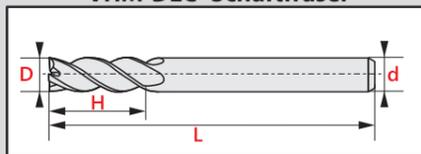

VHM-DLC- Schaftfräser mit Eckenradius

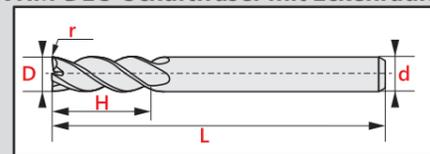

P Stahl **M** Edelstahl **K** Guss **S** Sonderwerkstoffe **H** Harte Werkstoffe **N** NE-Metalle

Komplette Träger-Zubehörliste mit Art. Nr. und Preise auf Seite 81.

Anwendungen

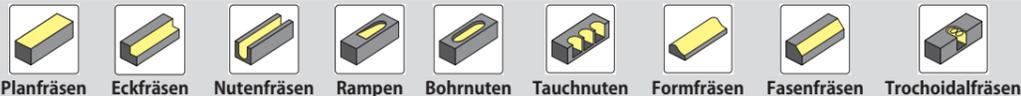

VHM-ALU-SCHAFTFRÄSER 3 Z MIT ECKENRADIUS (DLC BESCHICHTET)

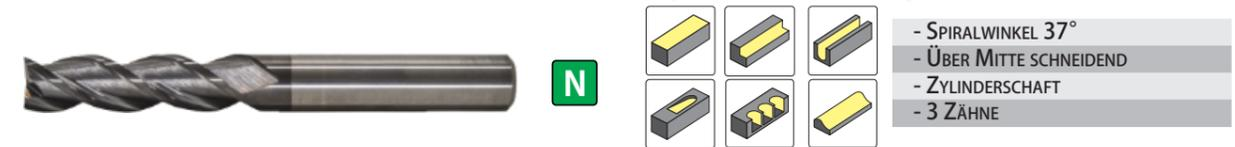

- SPIRALWINKEL 37°
- ÜBER MITTE SCHNEIDEND
- ZYLINDERSCHAFT
- 3 ZÄHNE

Art. Nr.	r	D	d(h5)	H	L		
2551701	AF-Z3-D6.0-R0,5 RT107	0,5	6,0	6	13	57	23,90 €
2551702	AF-Z3-D6.0-R1,0 RT107	1,0	6,0	6	13	57	23,90 €
2551703	AF-Z3-D6.0-R1,5 RT107	1,5	6,0	6	13	57	23,90 €
2551704	AF-Z3-D8.0-R0,3 RT107	0,3	8,0	8	19	63	36,20 €
2551705	AF-Z3-D8.0-R0,5 RT107	0,5	8,0	8	19	63	36,20 €
2551706	AF-Z3-D8.0-R1,0 RT107	1,0	8,0	8	19	63	36,20 €
2551707	AF-Z3-D8.0-R1,5 RT107	1,5	8,0	8	19	63	36,20 €
2551708	AF-Z3-D10.0-R0,3 RT107	0,3	10,0	10	22	72	51,90 €
2551709	AF-Z3-D10.0-R0,5 RT107	0,5	10,0	10	22	72	51,90 €
2551710	AF-Z3-D10.0-R1,0 RT107	1,0	10,0	10	22	72	51,90 €
2551711	AF-Z3-D10.0-R1,5 RT107	1,5	10,0	10	22	72	51,90 €
2551712	AF-Z3-D12.0-R1,5 RT107	1,5	12,0	12	26	83	74,90 €
2551713	AF-Z3-D12.0-R2,0 RT107	2,0	12,0	12	26	83	74,90 €
2551714	AF-Z3-D12.0-R2,5 RT107	2,5	12,0	12	26	83	74,90 €
2551715	AF-Z3-D12.0-R3,0 RT107	3,0	12,0	12	26	83	74,90 €
2551716	AF-Z3-D16.0-R1,5 RT107	1,5	16,0	16	32	92	128,90 €
2551717	AF-Z3-D16.0-R2,0 RT107	2,0	16,0	16	32	92	128,90 €
2551718	AF-Z3-D16.0-R2,5 RT107	2,5	16,0	16	32	92	128,90 €
2551719	AF-Z3-D16.0-R3,0 RT107	3,0	16,0	16	32	92	128,90 €
2551720	AF-Z3-D16.0-R4,0 RT107	4,0	16,0	16	32	92	128,90 €
2551721	AF-Z3-D20.0-R2,0 RT107	2,0	20,0	20	38	104	189,90 €
2551722	AF-Z3-D20.0-R2,5 RT107	2,5	20,0	20	38	104	189,90 €
2551723	AF-Z3-D20.0-R3,0 RT107	3,0	20,0	20	38	104	189,90 €
2551724	AF-Z3-D20.0-R4,0 RT107	4,0	20,0	20	38	104	189,90 €

VHM-ALU-SCHAFTFRÄSER 3Z MIT ECKENRADIUS LANGVERSION (DLC BESCHICHTET)



- SPIRALWINKEL 37°
- ÜBER MITTE SCHNEIDEND
- ZYLINDERSCHAFT
- 3 ZÄHNE

Art. Nr.	r	D	d(h5)	H	L		
2551741	AFL-Z3-D6.0-R0,5 RT107	0,5	6,0	6	24	75	31,10 €
2551742	AFL-Z3-D6.0-R1,0 RT107	1,0	6,0	6	24	75	31,10 €
2551743	AFL-Z3-D8.0-R0,5 RT107	0,5	8,0	8	32	75	45,60 €
2551744	AFL-Z3-D8.0-R1,0 RT107	1,0	8,0	8	32	75	45,60 €
2551745	AFL-Z3-D8.0-R1,5 RT107	1,5	8,0	8	32	75	45,60 €
2551746	AFL-Z3-D8.0-R2,0 RT107	2,0	8,0	8	32	75	45,60 €
2551747	AFL-Z3-D10.0-R0,5 RT107	0,5	10,0	10	40	100	64,90 €
2551748	AFL-Z3-D10.0-R1,0 RT107	1,0	10,0	10	40	100	64,90 €
2551749	AFL-Z3-D10.0-R1,5 RT107	1,5	10,0	10	40	100	64,90 €
2551750	AFL-Z3-D10.0-R2,0 RT107	2,0	10,0	10	40	100	64,90 €
2551751	AFL-Z3-D12.0-R0,5 RT107	0,5	12,0	12	48	100	102,80 €
2551752	AFL-Z3-D12.0-R1,0 RT107	1,0	12,0	12	48	100	102,80 €
2551753	AFL-Z3-D12.0-R1,5 RT107	1,5	12,0	12	48	100	102,80 €
2551754	AFL-Z3-D12.0-R2,0 RT107	2,0	12,0	12	48	100	102,80 €
2551755	AFL-Z3-D12.0-R2,5 RT107	2,5	12,0	12	48	100	102,80 €
2551756	AFL-Z3-D12.0-R3,0 RT107	3,0	12,0	12	48	100	102,80 €
2551757	AFL-Z3-D16.0-R0,5 RT107	0,5	16,0	16	64	125	151,90 €
2551758	AFL-Z3-D16.0-R1,0 RT107	1,0	16,0	16	64	125	151,90 €
2551759	AFL-Z3-D16.0-R1,5 RT107	1,5	16,0	16	64	125	151,90 €
2551760	AFL-Z3-D16.0-R2,0 RT107	2,0	16,0	16	64	125	151,90 €
2551761	AFL-Z3-D16.0-R2,5 RT107	2,5	16,0	16	64	125	151,90 €
2551762	AFL-Z3-D16.0-R3,0 RT107	3,0	16,0	16	64	125	151,90 €
2551763	AFL-Z3-D16.0-R4,0 RT107	4,0	16,0	16	64	125	151,90 €
2551764	AFL-Z3-D20.0-R0,5 RT107	0,5	20,0	20	80	150	239,00 €
2551765	AFL-Z3-D20.0-R1,0 RT107	1,0	20,0	20	80	150	239,00 €
2551766	AFL-Z3-D20.0-R1,5 RT107	1,5	20,0	20	80	150	239,00 €
2551767	AFL-Z3-D20.0-R2,0 RT107	2,0	20,0	20	80	150	239,00 €
2551768	AFL-Z3-D20.0-R2,5 RT107	2,5	20,0	20	80	150	239,00 €
2551769	AFL-Z3-D20.0-R3,0 RT107	3,0	20,0	20	80	150	239,00 €
2551770	AFL-Z3-D20.0-R4,0 RT107	4,0	20,0	20	80	150	239,00 €

VHM-HARTFRÄSER - FÜR DIE BEARBEITUNG VON STAHL BIS 68 HRC

VHM HARTFRÄSER Z=4 - STANDARDLÄNGE



- SPIRALWINKEL 45°
- ÜBER MITTE SCHNEIDEND
- ZYLINDERSCHAFT
- 4 ZÄHNE

Art. Nr.	D	d(h6)	H	L	Z	Geom.		
2551141	HF-Z4-D1.0 RT555	1	6	3	50	4	A	15,00 €
2551142	HF-Z4-D2.0 RT555	2	6	6	50	4	A	15,00 €
2551143	HF-Z4-D3.0 RT555	3	6	8	50	4	A	17,00 €
2551144	HF-Z4-D4.0 RT555	4	6	11	50	4	A	17,00 €
2551145	HF-Z4-D5.0 RT555	5	6	13	50	4	A	17,00 €
2551146	HF-Z4-D5.5 RT555	5,5	6	16	50	4	A	17,00 €
2551147	HF-Z4-D6.0 RT555	6	6	16	50	4	B	17,00 €
2551148	HF-Z4-D8.0 RT555	8	8	20	60	4	B	26,90 €
2551149	HF-Z4-D10.0 RT555	10	10	25	75	4	B	42,90 €
2551150	HF-Z4-D12.0 RT555	12	12	30	75	4	B	49,00 €
2551151	HF-Z4-D14.0 RT555	14	14	32	75	4	B	77,50 €
2551152	HF-Z4-D16.0 RT555	16	16	45	100	4	B	96,00 €
2551153	HF-Z4-D18.0 RT555	18	18	45	100	4	B	139,00 €
2551154	HF-Z4-D20.0 RT555	20	20	45	100	4	B	149,00 €

VHM HARTFRÄSER Z=4 - LANGVERSION



- SPIRALWINKEL 45°
- ÜBER MITTE SCHNEIDEND
- ZYLINDERSCHAFT
- 4 ZÄHNE

Art. Nr.	D	d(h6)	H	L	Z	Geom.		
2551311	HFL-Z4-D3.0 RT555	3	6	12	75	4	A	19,90 €
2551312	HFL-Z4-D4.0 RT555	4	6	15	75	4	A	19,90 €
2551313	HFL-Z4-D5.0 RT555	5	6	20	75	4	A	19,90 €
2551314	HFL-Z4-D6.0 RT555	6	6	20	75	4	B	19,90 €
2551315	HFL-Z4-D8.0 RT555	8	8	25	100	4	B	37,90 €
2551316	HFL-Z4-D10.0 RT555	10	10	30	100	4	B	53,90 €
2551317	HFL-Z4-D12.0 RT555	12	12	35	100	4	B	69,90 €
2551318	HFL-Z4-D14.0 RT555	14	14	40	100	4	B	84,90 €
2551319	HFL-Z4-D16.0 RT555	16	16	50	150	4	B	117,90 €
2551320	HFL-Z4-D20.0 RT555	20	20	55	150	4	B	196,90 €

VHM HART-TORUSFRÄSER Z=4



- SPIRALWINKEL 35°
- ÜBER MITTE SCHNEIDEND
- ZYLINDERSCHAFT
- 4 ZÄHNE

Art. Nr.	D	r	d(h6)	H	L	Z	Geom.		
2551381	HTFR-Z4-D3.0-R0.2 RT555	3	0,2	4	8	50	4	A	21,90 €
2551382	HTFR-Z4-D4.0-R0.3 RT555	4	0,3	4	10	50	4	B	21,90 €
2551383	HTFR-Z4-D4.0-R0.5 RT555	4	0,5	4	10	50	4	B	21,90 €
2551384	HTFR-Z4-D5.0-R0.5 RT555	5	0,5	6	13	50	4	A	23,90 €
2551385	HTFR-Z4-D5.0-R1.0 RT555	5	1	6	13	50	4	A	23,90 €
2551386	HTFR-Z4-D6.0-R0.5 RT555	6	0,5	6	16	50	4	B	23,90 €
2551387	HTFR-Z4-D6.0-R1,0 RT555	6	1	6	16	50	4	B	23,90 €
2551388	HTFR-Z4-D8.0-R0,5 RT555	8	0,5	8	20	60	4	B	33,90 €
2551389	HTFR-Z4-D8.0-R1,0 RT555	8	1	8	20	60	4	B	33,90 €
2551390	HTFR-Z4-D10.0-R0.5 RT555	10	0,5	10	25	75	4	B	49,90 €
2551391	HTFR-Z4-D10.0-R1.0 RT555	10	1	10	25	75	4	B	49,90 €
2551392	HTFR-Z4-D10.0-R2.0 RT555	10	2	10	25	75	4	B	49,90 €
2551393	HTFR-Z4-D10.0-R3.0 RT555	10	3	10	25	75	4	B	49,90 €
2551394	HTFR-Z4-D12.0-R0,5 RT555	12	0,5	12	30	75	4	B	63,90 €
2551395	HTFR-Z4-D12.0-R1.0 RT555	12	1	12	30	75	4	B	63,90 €
2551396	HTFR-Z4-D12.0-R2.0 RT555	12	2	12	30	75	4	B	63,90 €
2551397	HTFR-Z4-D12.0-R3.0 RT555	12	3	12	30	75	4	B	63,90 €

VHM-Hartfräser

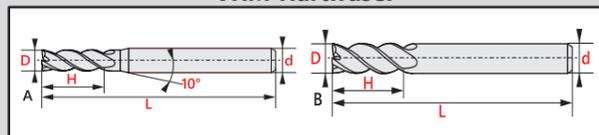

VHM-Torusfräser

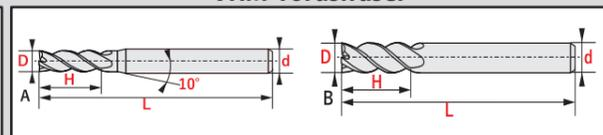

VHM-HART-KUGELFRÄSER - BEARBEITUNG VON STAHL BIS 68 HRC

VHM HART-KUGELFRÄSER Z=2 - STANDARDLÄNGE



- SPIRALWINKEL 35°
- ÜBER MITTE SCHNEIDEND
- ZYLINDERSCHAFT
- 2 ZÄHNE

Art. Nr.	D	r	d(h6)	H	L	Z	Geom.		
2551331	HKF-Z2-D1.0 RT555	1	0,5	6	2	50	2	A	27,50 €
2551332	HKF-Z2-D1.5 RT555	1,5	0,75	6	3	50	2	A	27,50 €
2551333	HKF-Z2-D2.0 RT555	2	1	6	4	50	2	A	27,50 €
2551334	HKF-Z2-D2.5 RT555	2,5	1,25	6	5	50	2	A	27,50 €
2551335	HKF-Z2-D3.0 RT555	3	1,5	6	6	50	2	A	27,50 €
2551336	HKF-Z2-D3.5 RT555	3,5	1,75	6	8	50	2	A	27,50 €
2551337	HKF-Z2-D4.0 RT555	4	2	6	8	50	2	A	27,50 €
2551338	HKF-Z2-D5.0 RT555	5	2,5	6	10	50	2	A	27,50 €
2551339	HKF-Z2-D5.5 RT555	5,5	2,75	6	12	50	2	A	27,50 €
2551340	HKF-Z2-D6.0 RT555	6	3	6	12	50	2	B	27,50 €
2551341	HKF-Z2-D8.0 RT555	8	4	8	16	60	2	B	36,90 €
2551342	HKF-Z2-D10.0 RT555	10	5	10	20	75	2	B	47,90 €
2551343	HKF-Z2-D12.0 RT555	12	6	12	24	75	2	B	58,50 €
2551344	HKF-Z2-D14.0 RT555	14	7	14	28	75	2	B	72,90 €
2551345	HKF-Z2-D16.0 RT555	16	8	16	32	100	2	B	97,80 €
2551346	HKF-Z2-D20.0 RT555	20	10	20	40	100	2	B	137,90 €

VHM HART-KUGELFRÄSER Z=2 - LANGVERSION



- SPIRALWINKEL 35°
- ÜBER MITTE SCHNEIDEND
- ZYLINDERSCHAFT
- 2 ZÄHNE

Art. Nr.	D	r	d(h6)	H	L	Z	Geom.		
2551351	HKFL-Z2-D2.0 RT555	2	1	6	4	75	2	A	32,00 €
2551352	HKFL-Z2-D2.5 RT555	2,5	1,25	6	6	75	2	A	32,00 €
2551353	HKFL-Z2-D3.0 RT555	3	1,5	6	6	75	2	A	32,00 €
2551354	HKFL-Z2-D3.5 RT555	3,5	1,75	6	8	75	2	A	32,00 €
2551355	HKFL-Z2-D4.0 RT555	4	2	6	8	75	2	A	32,00 €
2551356	HKFL-Z2-D5.0 RT555	5	2,5	6	10	75	2	A	32,00 €
2551357	HKFL-Z2-D5.5 RT555	5,5	2,75	6	12	75	2	A	32,00 €
2551358	HKFL-Z2-D6.0 RT555	6	3	6	12	75	2	B	32,00 €
2551359	HKFL-Z2-D8.0 RT555	8	4	8	16	100	2	B	43,20 €
2551360	HKFL-Z2-D10.0 RT555	10	5	10	20	100	2	B	54,50 €
2551361	HKFL-Z2-D12.0 RT555	12	6	12	24	100	2	B	68,90 €
2551362	HKFL-Z2-D14.0 RT555	14	7	14	28	100	2	B	85,90 €
2551363	HKFL-Z2-D16.0 RT555	16	8	16	32	150	2	B	127,90 €
2551364	HKFL-Z2-D20.0 RT555	20	10	20	40	150	2	B	179,00 €

VHM HART-KUGELFRÄSER Z=4



- SPIRALWINKEL 35°
- ÜBER MITTE SCHNEIDEND
- ZYLINDERSCHAFT
- 4 ZÄHNE

Art. Nr.	D	r	d(h6)	H	L	Z	Geom.		
2551941	HKF-Z4-D3.0 RT555	3	1,5	6	6	50	4	A	28,90 €
2551942	HKF-Z4-D4.0 RT555	4	2	6	8	50	4	A	28,90 €
2551943	HKF-Z4-D5.0 RT555	5	2,5	6	10	50	4	A	28,90 €
2551944	HKF-Z4-D6.0 RT555	6	3	6	12	50	4	B	28,90 €
2551945	HKF-Z4-D8.0 RT555	8	4	8	16	60	4	B	37,90 €
2551946	HKF-Z4-D10.0 RT555	10	5	10	20	75	4	B	48,90 €
2551947	HKF-Z4-D12.0 RT555	12	6	12	24	75	4	B	58,90 €
2551948	HKF-Z4-D14.0 RT555	14	7	14	28	75	4	B	83,90 €
2551949	HKF-Z4-D16.0 RT555	16	8	16	32	100	4	B	109,00 €
2551950	HKF-Z4-D18.0 RT555	18	9	18	36	100	4	B	139,00 €
2551951	HKF-Z4-D20.0 RT555	20	10	20	40	100	4	B	153,90 €

VHM-Hart-Kugelfräser Z=2

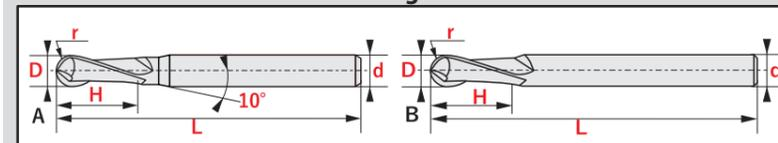

VHM-Hart-Kugelfräser Z=4

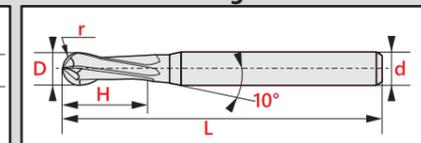

VHM-TITANFRÄSER - DER FRÄSER FÜR SONDERWERKSTOFFE

VHM-TITANFRÄSER Z=5 - STANDARDLÄNGE



S

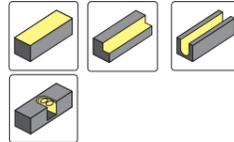

- ÜBER MITTE SCHNEIDEND
- ZYLINDERSCHAFT
- 5 ZÄHNE

Art. Nr.	D	d(h6)	H	L	Z	Eckfase		
2551856	TIF-Z5-D6.0 RT520	6	6	10	54	5	0,20	20,90 €
2551857	TIF-Z5-D8.0 RT520	8	8	12	58	5	0,20	29,40 €
2551858	TIF-Z5-D10.0 RT520	10	10	14	66	5	0,30	43,80 €
2551859	TIF-Z5-D12.0 RT520	12	12	16	73	5	0,35	57,70 €
2551860	TIF-Z5-D16.0 RT520	16	16	22	82	5	0,40	103,90 €
2551861	TIF-Z5-D20.0 RT520	20	20	26	92	5	0,50	145,90 €
2551862	TIF-Z5-D25.0 RT520	25	25	29	100	5	0,50	198,00 €

VHM-TITANFRÄSER Z=5 - LANGAUSFÜHRUNG



S

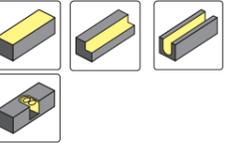

- ÜBER MITTE SCHNEIDEND
- ZYLINDERSCHAFT
- 5 ZÄHNE

Art. Nr.	D	d(h6)	H	L	Z	Eckfase		
2551871	TIFL-Z5-D6.0 RT520	6	6	13	57	5	0,20	21,90 €
2551872	TIFL-Z5-D8.0 RT520	8	8	19	63	5	0,20	30,50 €
2551873	TIFL-Z5-D10.0 RT520	10	10	22	72	5	0,30	49,20 €
2551874	TIFL-Z5-D12.0 RT520	12	12	26	83	5	0,35	61,90 €
2551875	TIFL-Z5-D16.0 RT520	16	16	36	92	5	0,40	103,90 €
2551876	TIFL-Z5-D20.0 RT520	20	20	44	104	5	0,50	174,90 €
2551877	TIFL-Z5-D25.0 RT520	25	25	54	121	5	0,50	236,00 €

VHM-Titanfräser

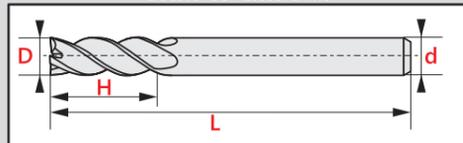

VHM-Titanfräser mit Eckradius

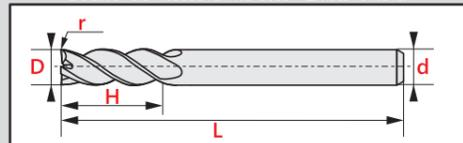

P Stahl M Edelstahl K Guss S Sonderwerkstoffe H Harte Werkstoffe N NE-Metalle

Komplette Träger-Zubehörliste mit Art. Nr. und Preise auf Seite 81.

VHM-TITANFRÄSER MIT ECKRADIUS Z=5 - STANDARDLÄNGE



S

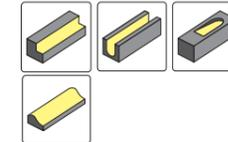

- ÜBER MITTE SCHNEIDEND
- ZYLINDERSCHAFT
- 5 ZÄHNE

Art. Nr.	D	d(h6)	H	L	Z	r		
2551881	TIFR-Z5-D6.0-R0,5 RT520	6	6	10	54	5	0,5	24,90 €
2551882	TIFR-Z5-D8.0-R0,5 RT520	8	8	12	58	5	0,5	34,90 €
2551883	TIFR-Z5-D10.0-R0,5 RT520	10	10	14	66	5	0,5	50,90 €
2551884	TIFR-Z5-D12.0-R0,5 RT520	12	12	16	73	5	0,5	74,80 €
2551885	TIFR-Z5-D16.0-R1,0 RT520	16	16	22	82	5	1,0	117,90 €
2551886	TIFR-Z5-D20.0-R1,0 RT520	20	20	26	92	5	1,0	176,50 €
2551887	TIFR-Z5-D25.0-R1,0 RT520	25	25	29	100	5	1,0	238,00 €

VHM-TITANFRÄSER MIT ECKRADIUS Z=5 - LANGVERSION



S

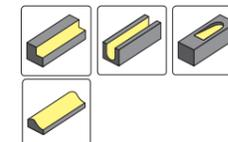

- ÜBER MITTE SCHNEIDEND
- ZYLINDERSCHAFT
- 5 ZÄHNE

Art. Nr.	D	d(h6)	H	L	Z	r		
2551891	TIFRL-Z5-D6.0-R0,3 RT520	6	6	13	57	5	0,3	26,20 €
2551892	TIFRL-Z5-D6.0-R0,5 RT520	6	6	13	57	5	0,5	26,20 €
2551893	TIFRL-Z5-D6.0-R1,0 RT520	6	6	13	57	5	1,0	26,20 €
2551894	TIFRL-Z5-D8.0-R0,5 RT520	8	8	19	63	5	0,5	36,40 €
2551895	TIFRL-Z5-D8.0-R1,0 RT520	8	8	19	63	5	1,0	36,40 €
2551896	TIFRL-Z5-D8.0-R1,5 RT520	8	8	19	63	5	1,5	36,40 €
2551897	TIFRL-Z5-D8.0-R2,0 RT520	8	8	19	63	5	2,0	36,40 €
2551898	TIFRL-Z5-D10.0-R0,5 RT520	10	10	22	72	5	0,5	57,40 €
2551899	TIFRL-Z5-D10.0-R1,0 RT520	10	10	22	72	5	1,0	57,40 €
2551900	TIFRL-Z5-D10.0-R1,5 RT520	10	10	22	72	5	1,5	57,40 €
2551901	TIFRL-Z5-D10.0-R2,0 RT520	10	10	22	72	5	2,0	57,40 €
2551902	TIFRL-Z5-D12.0-R0,5 RT520	12	12	26	83	5	0,5	73,20 €
2551903	TIFRL-Z5-D12.0-R1,0 RT520	12	12	26	83	5	1,0	73,20 €
2551904	TIFRL-Z5-D12.0-R1,5 RT520	12	12	26	83	5	1,5	73,20 €
2551905	TIFRL-Z5-D12.0-R2,0 RT520	12	12	26	83	5	2,0	73,20 €
2551906	TIFRL-Z5-D12.0-R2,5 RT520	12	12	26	83	5	2,5	73,20 €
2551907	TIFRL-Z5-D12.0-R3,0 RT520	12	12	26	83	5	3,0	73,20 €
2551908	TIFRL-Z5-D16.0-R1,0 RT520	16	16	36	92	5	1,0	122,00 €
2551909	TIFRL-Z5-D16.0-R1,5 RT520	16	16	36	92	5	1,5	122,00 €
2551910	TIFRL-Z5-D16.0-R2,0 RT520	16	16	36	92	5	2,0	122,00 €
2551911	TIFRL-Z5-D16.0-R2,5 RT520	16	16	36	92	5	2,5	122,00 €
2551912	TIFRL-Z5-D16.0-R3,0 RT520	16	16	36	92	5	3,0	122,00 €
2551913	TIFRL-Z5-D16.0-R4,0 RT520	16	16	36	92	5	4,0	122,00 €
2551914	TIFRL-Z5-D20.0-R1,0 RT520	20	20	44	104	5	1,0	206,90 €
2551915	TIFRL-Z5-D20.0-R1,5 RT520	20	20	44	104	5	1,5	206,90 €
2551916	TIFRL-Z5-D20.0-R2,0 RT520	20	20	44	104	5	2,0	206,90 €
2551917	TIFRL-Z5-D20.0-R2,5 RT520	20	20	44	104	5	2,5	206,90 €
2551918	TIFRL-Z5-D20.0-R3,0 RT520	20	20	44	104	5	3,0	206,90 €
2551919	TIFRL-Z5-D20.0-R4,0 RT520	20	20	44	104	5	4,0	206,90 €
2551920	TIFRL-Z5-D20.0-R5,0 RT520	20	20	44	104	5	5,0	206,90 €
2551921	TIFRL-Z5-D25.0-R1,0 RT520	25	25	54	121	5	1,0	284,90 €
2551922	TIFRL-Z5-D25.0-R1,5 RT520	25	25	54	121	5	1,5	284,90 €
2551923	TIFRL-Z5-D25.0-R2,0 RT520	25	25	54	121	5	2,0	284,90 €
2551924	TIFRL-Z5-D25.0-R2,5 RT520	25	25	54	121	5	2,5	284,90 €
2551925	TIFRL-Z5-D25.0-R3,0 RT520	25	25	54	121	5	3,0	284,90 €
2551926	TIFRL-Z5-D25.0-R4,0 RT520	25	25	54	121	5	4,0	284,90 €
2551927	TIFRL-Z5-D25.0-R5,0 RT520	25	25	54	121	5	5,0	284,90 €

Anwendungen

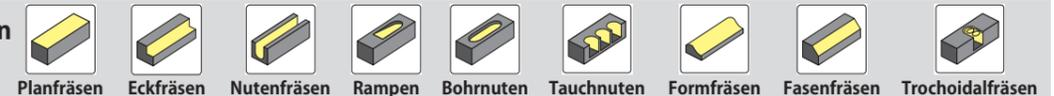

VHM-SCHAFTFRÄSER SCHRUPPBEARBEITUNG

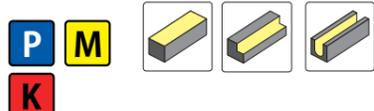

- 30° SPIRALWINKEL
- ÜBER MITTE SCHNEIDEND
- ZYLINDERSCHAFT
- SCHRUPPEN

Art. Nr.		D	d(h5)	H	L	Z	
2551671	SFR-Z3-D6,0 RT405	6	6	16	57	3	20,90 €
2551672	SFR-Z3-D8,0 RT405	8	8	16	63	3	26,20 €
2551673	SFR-Z4-D10,0 RT405	10	10	22	72	4	37,70 €
2551674	SFR-Z4-D12,0 RT405	12	12	26	83	4	50,40 €
2551677	SFR-Z4-D14,0 RT405	14	14	26	83	4	61,50 €
2551675	SFR-Z4-D16,0 RT405	16	16	32	92	4	78,40 €
2551678	SFR-Z4-D18,0 RT405	18	18	32	92	4	97,50 €
2551676	SFR-Z4-D20,0 RT405	20	20	38	104	4	104,50 €
2551679	SFR-Z5-D25,0 RT405	25	25	45	121	5	219,00 €

VHM-GEWINDEFÄSER



- ZYLINDERSCHAFT
- GEWINDEFÄSEN

Art. Nr.		Gewinde	P	D	d(h6)	L	H	Z	Kernloch	
2551631	HGF-Z3-M3x0,5 RT402	M3	0,5	2,35	4	50	6	3	2,5	39,90 €
2551632	HGF-Z3-M4x0,7 RT402	M4	0,7	3,15	4	50	8	3	3,3	44,90 €
2551633	HGFF-Z3-M5x0,5 RT402	* M5	0,5	4,3	6	50	10	3	4,5	49,90 €
2551634	HGF-Z3-M5x0,8 RT402	M5	0,8	4,0	6	50	10	3	4,2	49,90 €
2551635	HGFF-Z4-M6x0,75 RT402	* M6	0,75	5,0	6	60	12	4	5,25	56,90 €
2551636	HGF-Z4-M6x1,0 RT402	M6	1	4,75	6	60	12	4	5	56,90 €
2551637	HGFF-Z4-M8x1,0 RT402	* M8	1	6,65	8	60	16	4	7	72,90 €
2551638	HGF-Z4-M8x1,25 RT402	M8	1,25	6,45	8	60	16	4	6,75	72,90 €
2551639	HGFF-Z4-M10x1 RT402	* M10	1	8,85	10	75	20	4	9	89,90 €
2551640	HGF-Z4-M10x1,5 RT402	M10	1,5	8,1	10	75	20	4	8,5	89,90 €
2551641	HGFF-Z4-M12x1,25 RT402	* M12	1,25	10,25	12	75	24	4	10,75	117,90 €
2551642	HGF-Z4-M12x1,75 RT402	M12	1,75	9,75	12	75	24	4	10,25	117,90 €
2551643	HGFF-Z4-M14x1,0 RT402	* M14	1	12,35	14	75	20	4	13	154,50 €
2551644	HGFF-Z4-M14x1,5 RT402	* M14	1,5	11,9	14	75	28	4	12,5	154,50 €
2551645	HGF-Z4-M14x2,0 RT402	M14	2	11,4	14	75	28	4	12	154,50 €
2551646	HGF-Z6-M16x2,0 RT402	M16	2	13,3	16	90	32	6	14	187,90 €
2551647	HGFF-Z6-M18x1,0 RT402	* M18	1	16,15	18	90	20	6	17	243,70 €
2551648	HGF-Z6-M18x2,5 RT402	M18	2,5	14,75	18	90	36	6	15,5	243,70 €
2551649	HGFF-Z6-M20x2,0 RT402	* M20	2	17,1	18	100	40	6	18	269,00 €
2551650	HGF-Z6-M20x2,5 RT402	M20	2,5	16,65	18	100	40	6	17,5	269,00 €

*= Feingewinde

Bearbeitungsbeispiel VHM-Gewindefräser

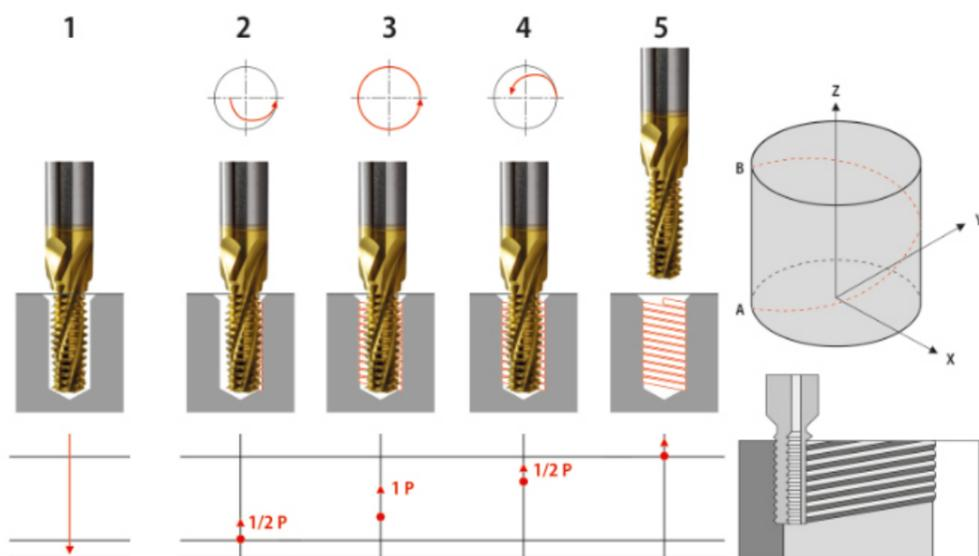

HSSCo8-FRÄSER-R- (SCHRUPPEN)

HSSCo8-FRÄSER-R- (SCHRUPPEN)

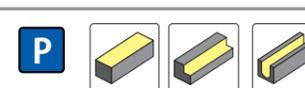

- 30° SPIRALWINKEL
- ÜBER MITTE SCHNEIDEND
- WELDON SCHAFT
- SCHRUPPEN

Art. Nr.		D	d(h6)	H	L	Z	
2351031	HSSCo8-Z3-D6,0-RT-SR-TIALN	6,0	6	13	57	3	18,80 €
2351033	HSSCo8-Z3-D8,0-RT-SR-TIALN	8,0	10	19	69	3	20,90 €
2351034	HSSCo8-Z4-D10,0-RT-SR-TIALN	10,0	10	22	72	4	21,70 €
2351035	HSSCo8-Z4-D12,0-RT-SR-TIALN	12,0	12	26	83	4	22,90 €
2351037	HSSCo8-Z4-D16,0-RT-SR-TIALN	16,0	16	32	92	4	31,90 €
2351039	HSSCo8-Z4-D20,0-RT-SR-TIALN	20,0	20	38	104	4	40,50 €

HSSCo8-FRÄSER (SCHLICHTEN)

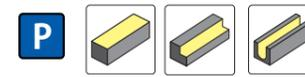

- 30° SPIRALWINKEL
- ÜBER MITTE SCHNEIDEND
- WELDON SCHAFT
- SCHLICHTEN

Art. Nr.		D	d(h6)	H	L	Z	
2351001	HSSCo8-Z4-D2,0-RT-SF-TIALN	2,0	6	7	51	4	9,50 €
2351002	HSSCo8-Z4-D3,0-RT-SF-TIALN	3,0	6	8	52	4	9,50 €
2351003	HSSCo8-Z4-D4,0-RT-SF-TIALN	4,0	6	11	55	4	9,50 €
2351004	HSSCo8-Z4-D5,0-RT-SF-TIALN	5,0	6	13	57	4	9,50 €
2351005	HSSCo8-Z4-D6,0-RT-SF-TIALN	6,0	6	13	57	4	9,50 €
2351007	HSSCo8-Z4-D8,0-RT-SF-TIALN	8,0	10	19	69	4	12,50 €
2351008	HSSCo8-Z4-D10,0-RT-SF-TIALN	10,0	10	22	72	4	12,90 €
2351009	HSSCo8-Z4-D12,0-RT-SF-TIALN	12,0	12	26	83	4	15,20 €
2351011	HSSCo8-Z4-D16,0-RT-SF-TIALN	16,0	16	32	92	4	21,50 €
2351013	HSSCo8-Z4-D20,0-RT-SF-TIALN	20,0	20	38	98	4	33,90 €
2351014	HSSCo8-Z4-D25,0-RT-SF-TIALN	25,0	25	45	121	4	44,50 €

VHM-Schrupffräser

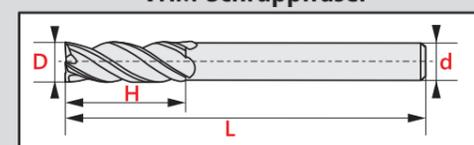

VHM-Gewindefräser

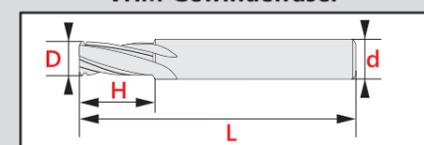

HSS-Fräser

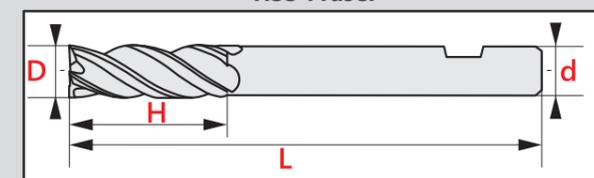

P Stahl **M** Edelstahl **K** Guss **S** Sonderwerkstoffe **H** Harte Werkstoffe **N** NE-Metalle

Komplette Träger-Zubehörliste mit Art. Nr. und Preise auf Seite 81.

Anwendungen

WENDEPLATTENBOHRER SPMG



	D	d	* = 3xd		* = 4xd	
			L3	Preis	L3	Preis
SPMG 050204						
SDUM 12,5* SPMG 050204	12,5	20	37	112,00 €	52	141,00 €
SDUM 13* SPMG 050204	13	20	39	112,00 €	52	141,00 €
SDUM 13,5* SPMG 050204	13,5	20	40,5	112,00 €	52	141,00 €
SDUM 14* SPMG 050204	14	20	42	112,00 €	56	141,00 €
SDUM 14,5* SPMG 050204	14,5	20	43,5	112,00 €	56	141,00 €
SDUM 15* SPMG 050204	15	20	45	112,00 €	60	141,00 €
SPMG 060204						
SDUM 15,5* SPMG 060204	15,5	20	46,5	112,00 €	60	141,00 €
SDUM 16* SPMG 060204	16	25	48	112,00 €	64	141,00 €
SDUM 16,5* SPMG 060204	16,5	25	49,5	112,00 €	66	141,00 €
SDUM 17* SPMG 060204	17	25	51	112,00 €	68	141,00 €
SDUM 17,5* SPMG 060204	17,5	25	52,5	112,00 €	70	141,00 €
SDUM 18* SPMG 060204	18	25	54	112,00 €	72	141,00 €
SDUM 18,5* SPMG 060204	18,5	25	55,5	112,00 €	74	141,00 €
SDUM 19* SPMG 060204	19	25	57	112,00 €	76	141,00 €
SDUM 19,5* SPMG 060204	19,5	25	58,5	112,00 €	78	141,00 €
SDUM 20* SPMG 060204	20	25	60	115,00 €	80	141,00 €
SDUM 20,5* SPMG 060204	20,5	25	61,5	115,00 €	82	141,00 €
SDUM 21* SPMG 060204	21	25	63	115,00 €	84	148,00 €
SDUM 21,5* SPMG 060204	21,5	25	64,5	115,00 €	86	148,00 €
SPMG 07T308						
SDUM 22* SPMG 07T308	22	25	66	115,00 €	88	148,00 €
SDUM 22,5* SPMG 07T308	22,5	25	67,5	115,00 €	90	148,00 €
SDUM 23* SPMG 07T308	23	25	69	115,00 €	92	148,00 €
SDUM 23,5* SPMG 07T308	23,5	25	70,5	115,00 €	94	148,00 €
SDUM 24* SPMG 07T308	24	25	72	115,00 €	96	148,00 €
SDUM 24,5* SPMG 07T308	24,5	25	73,5	115,00 €	98	148,00 €
SDUM 25* SPMG 07T308	25	25	75	119,00 €	100	148,00 €
SDUM 25,5* SPMG 07T308	25,5	25	76,5	119,00 €	102	148,00 €
SDUM 26* SPMG 07T308	26	25	78	119,00 €	104	165,00 €
SDUM 26,5* SPMG 07T308	26,5	25	79,5	119,00 €	106	165,00 €
SDUM 27* SPMG 07T308	27	25	81	119,00 €	108	165,00 €
SDUM 27,5* SPMG 07T308	27,5	25	82,5	119,00 €	110	165,00 €
SPMG 090408						
SDUM 28* SPMG 090408	28	25	84	119,00 €	112	165,00 €
SDUM 28,5* SPMG 090408	28,5	25	85,5	119,00 €	114	165,00 €
SDUM 29* SPMG 090408	29	25	87	119,00 €	116	165,00 €
SDUM 29,5* SPMG 090408	29,5	25	88,5	119,00 €	118	165,00 €
SDUM 30* SPMG 090408	30	32	90	124,00 €	120	176,00 €
SDUM 31* SPMG 090408	31	32	93	124,00 €	124	176,00 €
SDUM 32* SPMG 090408	32	32	96	124,00 €	128	176,00 €
SDUM 33* SPMG 090408	33	32	99	124,00 €	132	176,00 €
SPMG 110408						
SDUM 34* SPMG 110408	34	32	102	124,00 €	136	176,00 €
SDUM 35* SPMG 110408	35	32	105	124,00 €	140	176,00 €
SDUM 36* SPMG 110408	36	32	108	124,00 €	144	176,00 €
SDUM 37* SPMG 110408	37	32	111	124,00 €	148	186,00 €
SDUM 38* SPMG 110408	38	32	114	124,00 €	152	186,00 €
SDUM 39* SPMG 110408	39	32	117	124,00 €	156	186,00 €
SDUM 40* SPMG 110408	40	32	120	12400 €	160	186,00 €

Zubehör



SCHRAUBEN

SPMG 050204:	SSV M2x5 - 9502 (T06)
SPMG 060204:	SSV M2,2x5 - 9503 (T06)
SPMG 07T308:	SSV M2,5x7 - 9506 (T08)
SPMG 090408:	SSV M3,5x10 - 9511 (T15)
SPMG 110408:	SSV M4x10 - 9514 (T15)

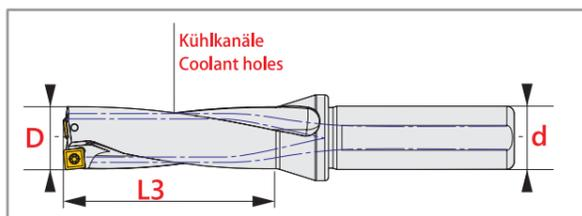

Art. Nr. SPMG - PM

3101411	SPMG 050204-PM RT300	4,70 €
3101412	SPMG 060204-PM RT300	4,90 €
3101413	SPMG 07T308-PM RT300	5,60 €
3101414	SPMG 090408-PM RT300	6,00 €
3101415	SPMG 110408-PM RT300	6,60 €
3101416	SPMG 140512-PM RT300	7,10 €



Komplette Träger-Zubehörliste mit Art. Nr. und Preise auf Seite 81.

WENDEPLATTENBOHRER WCMX

	D	d	* = 2xd		* = 3xd		* = 4xd		* = 5xd	
			L3	Preis	L3	Preis	L3	Preis	L3	Preis
WC...030208										
SDUM 16* WCM.030208	16	25	32	106,00 €	48	106,00 €	64	139,00 €	80	176,00 €
SDUM 16,5* WCM.030208	16,5	25	33	106,00 €	49,5	106,00 €	66	139,00 €	85	176,00 €
SDUM 17* WCM.030208	17	25	34	106,00 €	51	106,00 €	68	139,00 €	85	176,00 €
SDUM 17,5* WCM.030208	17,5	25	35	106,00 €	52,5	106,00 €	70	139,00 €	90	176,00 €
SDUM 18* WCM.030208	18	25	36	106,00 €	54	106,00 €	72	139,00 €	90	176,00 €
SDUM 18,5* WCM.030208	18,5	25	37	106,00 €	55,5	106,00 €	74	139,00 €	95	186,00 €
SDUM 19* WCM.030208	19	25	38	106,00 €	57	106,00 €	76	139,00 €	95	186,00 €
SDUM 19,5* WCM.030208	19,5	25	39	106,00 €	58,5	106,00 €	78	139,00 €	100	186,00 €
SDUM 20* WCM.040208	20	25	40	109,00 €	60	109,00 €	80	148,00 €	100	186,00 €
SDUM 20,5* WCM.040208	20,5	25	41	109,00 €	61,5	109,00 €	82	148,00 €	105	186,00 €
SDUM 21* WCM.040208	21	25	42	109,00 €	63	109,00 €	84	148,00 €	105	186,00 €
SDUM 21,5* WCM.040208	21,5	25	43	109,00 €	64,5	109,00 €	86	148,00 €	110	186,00 €
SDUM 22* WCM.040208	22	25	44	109,00 €	66	109,00 €	88	148,00 €	110	186,00 €
SDUM 22,5* WCM.040208	22,5	25	45	109,00 €	67,5	109,00 €	90	148,00 €	115	196,00 €
SDUM 23* WCM.040208	23	25	46	109,00 €	69	109,00 €	92	148,00 €	115	196,00 €
SDUM 23,5* WCM.040208	23,5	25	47	109,00 €	70,5	109,00 €	94	148,00 €	120	196,00 €
SDUM 24* WCM.050308	24	25	48	114,00 €	72	114,00 €	96	157,00 €	120	196,00 €
SDUM 24,5* WCM.050308	24,5	25	49	114,00 €	73,5	114,00 €	98	157,00 €	125	196,00 €
SDUM 25* WCM.050308	25	25	50	114,00 €	75	114,00 €	100	157,00 €	125	196,00 €
SDUM 25,5* WCM.050308	25,5	25	51	114,00 €	76,5	114,00 €	102	157,00 €	130	196,00 €
SDUM 26* WCM.050308	26	25	52	114,00 €	78	114,00 €	104	157,00 €	130	196,00 €
SDUM 26,5* WCM.050308	26,5	25	53	114,00 €	79,5	114,00 €	106	157,00 €	135	196,00 €
SDUM 27* WCM.050308	27	25	54	114,00 €	81	114,00 €	108	157,00 €	135	196,00 €
SDUM 27,5* WCM.050308	27,5	25	55	114,00 €	82,5	114,00 €	110	157,00 €	140	196,00 €
SDUM 28* WCM.050308	28	25	56	114,00 €	84	114,00 €	112	157,00 €	140	196,00 €
SDUM 28,5* WCM.050308	28,5	25	57	114,00 €	85,5	114,00 €	114	157,00 €	145	196,00 €
SDUM 29* WCM.050308	29	25	58	114,00 €	87	114,00 €	116	157,00 €	145	196,00 €
SDUM 29,5* WCM.050308	29,5	25	59	114,00 €	88,5	114,00 €	118	157,00 €	150	196,00 €
SDUM 30* WCM.06T308	30	32	60	122,00 €	90	122,00 €	120	166,00 €	150	196,00 €
SDUM 31* WCM.06T308	31	32	62	122,00 €	93	122,00 €	124	166,00 €	155	203,00 €
SDUM 32* WCM.06T308	32	32	64	122,00 €	96	122,00 €	128	166,00 €	160	203,00 €
SDUM 33* WCM.06T308	33	32	66	122,00 €	99	122,00 €	132	166,00 €	165	203,00 €
SDUM 34* WCM.06T308	34	32	68	122,00 €	102	122,00 €	136	166,00 €	170	203,00 €
SDUM 35* WCM.06T308	35	32	70	122,00 €	105	122,00 €	140	166,00 €	175	218,00 €
SDUM 36* WCM.06T308	36	32	72	122,00 €	108	122,00 €	144	166,00 €	180	218,00 €
SDUM 37* WCM.06T308	37	32	74	122,00 €	111	122,00 €	148	166,00 €	185	218,00 €
SDUM 38* WCM.06T308	38	32	76	122,00 €	114	122,00 €	152	166,00 €	190	246,00 €
SDUM 39* WCM.06T308	39	32	78	122,00 €	117	122,00 €	156	166,00 €	195	246,00 €
SDUM 40* WCM.06T308	40	32	80	132,00 €	120	132,00 €	160	195,00 €	200	246,00 €
SDUM 41* WCM.06T308	41	32			123	132,00 €	164	195,00 €		
SDUM 42* WCM.06T308	42	32			126	132,00 €	168	195,00 €		
SDUM 43* WCM.06T308	43	32			129	132,00 €	172	195,00 €		
SDUM 44* WCM.06T308	44	32			132	132,00 €	176	195,00 €		



Wendepplattenbohrer 2xD
& 3xD bis Ø60mm auf Lager



Art. Nr. Stahl/Edelstahl

3201041	WCMX 030208-UNI RT330	4,90 €
3201042	WCMX 040208-UNI RT330	4,90 €
3201043	WCMX 050308-UNI RT330	5,10 €
3201044	WCMX 06T308-UNI RT330	5,10 €
3201045	WCMX 080412-UNI RT330	5,30 €

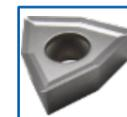

Art. Nr. Kunststoffe / NE-Metalle

3201001	WCMX 030208R-AL RT100	4,90 €
3201002	WCMX 040208R-AL RT100	4,90 €
3201003	WCMX 050308R-AL RT100	5,10 €
3201004	WCMX 06T308R-AL RT100	5,10 €
3201005	WCMX 080408R-AL RT100	5,40 €

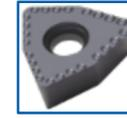

Art. Nr. Edelstahl

3201061	WCMX 030208-R-51 RT300	4,70 €
3201062	WCMX 040208-R-51 RT300	4,70 €
3201063	WCMX 050308-R-51 RT300	4,90 €
3201064	WCMX 06T308-R-51 RT300	4,90 €
3201065	WCMX 080412-R-51 RT300	5,20 €

Zubehör



SCHRAUBEN

WCMX 030208:	SSV M2,5x6 - 9505 (T08)
WCMX 040208:	SSV M2,5x6 - 9505 (T08)
WCMX 050308:	SSV M3x8 - 9508 (T08)
WCMX 06T308:	SSV M3,5x10 - 9511 (T15)

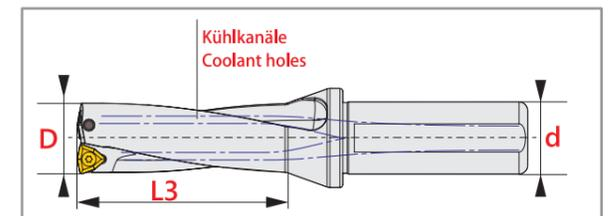

EINSTELLBARE SCHRUPP-SCHLICHT-SPINDELKÖPFE



Lieferumfang:

- 1 Grundkörper
- 2 Kassetten
- 2 Kassetten-Befestigungsschrauben
- 2 Einstellschrauben
- 2 TORX-Schrauben
- 1 TORX-Schlüssel



		D1 (min)	D2(max)	d1	d2	L	L1	L2	
SM15906	SBT-CC06 D20-24 I50 W16 L100	20	24	16	16	100	50	50	158,40 €
SM15937	SBT-CC06 D20-24 I100 W16 L150	20	24	16	16	150	100	50	167,20 €
SM16019	SBT-CC06 D20-24 I150 W16 L200	20	24	16	16	200	150	50	204,00 €
SM15913	SBT-CC06 D24-29 I50 W20 L100	24	29	20	22	100	50	50	164,80 €
SM23598	SBT-CC06 D24-29 I100 W20 L150	24	29	20	22	150	100	50	167,20 €
SM16026	SBT-CC06 D24-29 I180 W20 L230	24	29	20	22	230	180	50	204,00 €
SM15920	SBT-CC09 D29-39 I55 W20 L105	29	39	20	25	105	55	50	164,80 €
SM15968	SBT-CC09 D29-39 I105 W20 L155	29	39	20	25	155	105	50	180,00 €
SM15890	SBT-CC09 D29-39 I175 W20 L230	29	39	20	25	230	175	55	216,00 €
SM15944	SBT-CC09 D39-49 I65 W25 L120	39	49	25	32	120	65	55	164,80 €
SM15975	SBT-CC09 D39-49 I115 W25 L170	39	49	25	32	170	115	55	181,60 €
SM16057	SBT-CC09 D39-49 I200 W25 L250	39	49	25	32	250	200	55	221,60 €
SM15951	SBT-CC09 D49-60 I66 W32 L126	49	60	32	40	126	66	60	170,40 €
SM15883	SBT-CC09 D49-60 I116 W32 L176	49	60	32	40	176	116	60	192,80 €
SM16071	SBT-CC09 D49-60 I200 W32 L260	49	60	32	40	260	200	60	227,20 €
SM15982	SBT-CC12 D59-79 I85 W32 L145	59	79	32	50	145	85	60	187,20 €
SM16002	SBT-CC12 D59-79 I135 W32 L195	59	79	32	50	195	135	60	192,80 €
SM16088	SBT-CC12 D59-79 I220 W32 L280	59	79	32	50	280	220	60	240,80 €
SM15999	SBT-CC12 D69-89 I85 W32 L145	69	89	32	63	145	85	60	192,80 €
SM16033	SBT-CC12 D69-89 I135 W32 L195	69	89	32	63	195	135	60	209,60 €
SM39582	SBT-CC12 D69-89 I220 W32 L290	69	89	32	63	290	220	60	255,20 €
SM16095	SBT-CC12 D69-89 I220 W40 L290	69	89	40	63	290	220	60	255,20 €
SM16040	SBT-CC12 D89-130 I105 W32 L175	89	130	32	75	175	105	60	209,60 €
SM16064	SBT-CC12 D89-130 I165 W32 L225	89	130	32	75	225	165	60	221,60 €



Art. Nr.	CCMT...-HM RT300	
1771051	CCMT 060202-HM-RT300	2,95 €
1771052	CCMT 060204-HM-RT300	2,95 €
1771053	CCMT 060208-HM-RT300	2,95 €
1771054	CCMT 09T302-HM-RT300	3,49 €
1771055	CCMT 09T304-HM-RT300	3,49 €
1771056	CCMT 09T308-HM-RT300	3,49 €
1771057	CCMT 120404-HM-RT300	4,40 €
1771058	CCMT 120408-HM-RT300	4,40 €

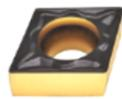

Art. Nr.	CCMT...-PM RT250+	
1771621	CCMT 060204-PM-RT250+	2,95 €
1771622	CCMT 09T304-PM-RT250+	3,49 €
1771623	CCMT 09T308-PM-RT250+	3,49 €

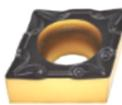

Art. Nr.	CCMT...-PR RT250+	
1771631	CCMT 09T304-PR-RT250+	3,49 €
1771632	CCMT 09T308-PR-RT250+	3,49 €



Art. Nr.	CCMT...-HF RT250X	
1771431	CCMT 060202-HF-RT250X	3,30 €
1771432	CCMT 060204-HF-RT250X	3,30 €
1771433	CCMT 060208-HF-RT250X	3,30 €
1771434	CCMT 09T302-HF-RT250X	3,90 €
1771435	CCMT 09T304-HF-RT250X	3,90 €
1771436	CCMT 09T308-HF-RT250X	3,90 €
1771437	CCMT 120404-HF-RT250X	4,50 €
1771438	CCMT 120408-HF-RT250X	4,50 €



Art. Nr.	CCGT...-ALZ RT100	
1771001	CCGT 060202-ALZ-RT100	3,00 €
1771002	CCGT 060204-ALZ-RT100	3,00 €
1771003	CCGT 060208-ALZ-RT100	3,00 €
1771004	CCGT 09T302-ALZ-RT100	3,30 €
1771005	CCGT 09T304-ALZ-RT100	3,30 €
1771006	CCGT 09T308-ALZ-RT100	3,30 €
1771007	CCGT 120404-ALZ-RT100	3,80 €
1771008	CCGT 120408-ALZ-RT100	3,80 €

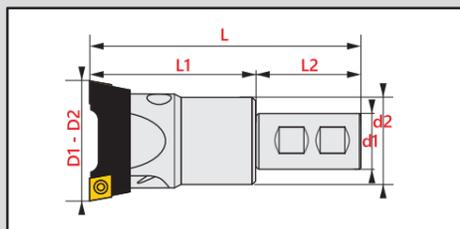

VHM-BOHRER FÜR STAHL, EDELSTAHL UND GUSS

VBU-BOHRER 3xD



D(m7)	Schaft Ø		Spirallänge				Bohrtiefe	
	d(h6)	L	L2	L3	L4	mit IK	ohne IK	
3 - 3,7 MM	6	62	20	14	36	21,90 €	15,60 €	
3,8 - 4,7 MM	6	66	24	17	36	21,90 €	15,60 €	
4,8 - 6 MM	6	66	28	20	36	21,90 €	15,60 €	
6,1 - 7 MM	8	79	34	24	36	27,90 €	17,90 €	
7,1 - 8 MM	8	79	41	29	36	27,90 €	17,90 €	
8,1 - 10 MM	10	89	47	35	40	33,90 €	20,90 €	
10,1 - 12 MM	12	102	55	40	45	47,90 €	27,90 €	
12,1 - 14 MM	14	107	60	43	45	66,00 €	40,90 €	
14,2 MM	14	107	60	43	45	89,90 €	48,90 €	
14,25 - 16 MM	16	115	65	45	48	89,90 €	48,90 €	
16,5 MM - 17,8 MM	18	123	73	51	48	117,90 €	72,00 €	
18 MM	18	123	73	51	48	117,90 €	84,00 €	
18,5 - 20 MM	20	131	79	55	50	142,50 €	84,00 €	



mit und ohne IK

Weldon Spannfläche oder Zylinderschaft

VBU-BOHRER 5xD



D(m7)	Schaft Ø		Spirallänge				Bohrtiefe	
	d(h6)	L	L2	L3	L4	mit IK	ohne IK	
3 MM	6	62	20	14	36	25,50 €	18,50 €	
3,1 - 3,7 MM	6	66	28	23	36	25,50 €	18,50 €	
3,8 - 4,7 MM	6	74	36	29	36	25,50 €	18,50 €	
4,8 - 6 MM	6	82	44	35	36	25,50 €	18,50 €	
6,1 - 8 MM	8	91	53	43	36	31,00 €	22,00 €	
8,1 - 10 MM	10	103	61	49	40	38,90 €	26,90 €	
10,1 - 12 MM	12	118	71	56	45	53,20 €	38,50 €	
12,1 - 14 MM	14	124	77	60	45	72,90 €	48,00 €	
14,2 - 16 MM	16	133	83	63	48	99,90 €	59,00 €	
16,5 - 18 MM	18	143	93	71	48	139,00 €	99,00 €	
18 MM	18	143	93	71	48	169,00 €	99,00 €	
18,5 20 MM	20	153	101	77	50	169,00 €	129,00 €	



mit und ohne IK

Weldon Spannfläche oder Zylinderschaft

VBU-BOHRER 8xD



D(m7)	Schaft Ø		Spirallänge				Bohrtiefe	
	d(h6)	L	L2	L3	L4	mit IK		
3 BIS 3,7 MM	6	72	34	29	36	49,00 €		
3,8 BIS 4,5 MM	6	81	43	36	36	49,00 €		
4,6 BIS 6 MM	6	95	57	48	36	53,00 €		
6,1 BIS 6,9 MM	8	114	76	66	36	69,00 €		
7,0 BIS 8 MM	8	116	76	66	36	69,00 €		
8,1 BIS 10 MM	10	142	95	83	40	92,90 €		
10,1 BIS 12 MM	12	162	114	99	45	114,00 €		
12,5 BIS 14 MM	14	178	133	116	45	164,00 €		
14,5 BIS 16 MM	16	204	152	132	48	209,90 €		
16,5 BIS 18 MM	18	223	171	149	48	274,00 €		

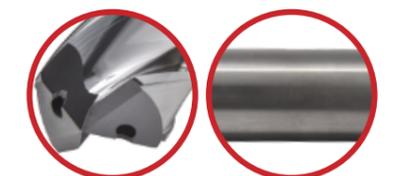

mit IK

Zylinderschaft

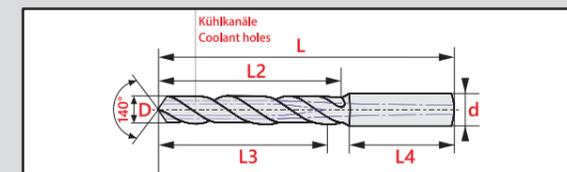

VHM-BOHRER FÜR EDELSTAHL UND SONDERWERKSTOFFE

VBS-BOHRER 3xD



D(m7)	Schaft Ø		Spirallänge		Bohrtiefe		Preis mit IK
	d(h6)	L	L2	L3	L4		
3 BIS 3,7 MM	6	62	20	14	36	21,90 €	
3,8 BIS 4,7 MM	6	66	24	17	36	21,90 €	
4,8 BIS 6 MM	6	66	28	20	36	21,90 €	
6,1 BIS 7,0 MM	8	79	34	24	36	27,90 €	
7,1 BIS 8 MM	8	79	41	29	36	27,90 €	
8,1 BIS 10 MM	10	89	47	35	40	33,90 €	
10,2 BIS 12 MM	12	102	55	40	45	47,90 €	
12,5 BIS 14 MM	14	107	60	43	45	66,00 €	
14,5 BIS 16 MM	16	115	65	45	48	89,00 €	
16,5	18	123	73	51	48	112,00 €	
17 BIS 18 MM	18	123	73	51	48	112,00 €	
18,5 BIS 19 MM	20	131	79	55	50	134,90 €	
19,5 BIS 20 MM	20	131	79	55	50	134,90 €	



Auch ab Ø1 mm mit IK erhältlich

VBS-BOHRER 5xD



D(m7)	Schaft Ø		Spirallänge		Bohrtiefe		Preis mit IK
	d(h6)	L	L2	L3	L4		
3 BIS 3,7 MM	6	66	28	23	36	24,90 €	
3,8 BIS 4,7 MM	6	74	36	29	36	24,90 €	
4,8 BIS 6 MM	6	82	44	35	36	24,90 €	
6,1 BIS 7,0 MM	8	91	53	43	36	31,00 €	
7,1 BIS 8 MM	8	91	53	43	36	31,00 €	
8,1 BIS 10 MM	10	103	61	49	40	38,60 €	
10,2 BIS 12 MM	12	118	71	56	45	53,20 €	
12,5 BIS 14 MM	14	124	77	60	45	71,90 €	
14,5 BIS 16 MM	16	133	83	63	48	99,00 €	
16,5	18	143	93	71	48	139,90 €	
17 BIS 18 MM	18	143	93	71	48	139,90 €	
18,5 BIS 19 MM	20	153	101	77	50	169,90 €	
19,5 BIS 20 MM	20	153	101	77	50	169,90 €	

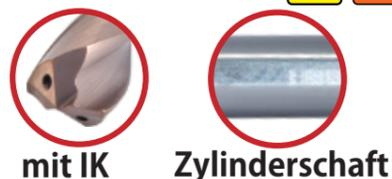

Auch ab Ø1 mm mit IK erhältlich

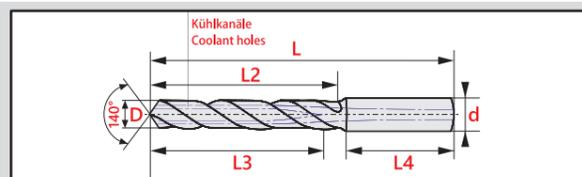

P Stahl **M** Edelstahl **K** Guss **S** Sonderwerkstoffe **H** Harte Werkstoffe **N** NE-Metalle

Komplette Träger-Zubehörliste mit Art. Nr. und Preise auf Seite 81.

NEU! 3-SCHNEIDEN HIGH FEED-BOHRER -STAHL & GUSS

VBH-BOHRER 3xD



D	Schaft Ø		Spirallänge		Gesamtlänge		Preis mit IK
	d(h6)	L2	L	L	L		
5 BIS 6 MM	6	28	66	46,90 €			
6,1 BIS 7 MM	8	34	79	62,50 €			
7,1 BIS 8 MM	8	41	79	62,50 €			
8,1 BIS 10 MM	10	47	89	67,90 €			
10,1 BIS 12 MM	12	55	102	92,90 €			
12,5 BIS 14 MM	14	60	107	124,90 €			
14,5 BIS 16 MM	16	65	115	155,90 €			
16,5 BIS 18 MM	18	73	123	254,50 €			
18,5 BIS 20 MM	20	79	131	269,50 €			



VBH-BOHRER 5xD



D	Schaft Ø		Spirallänge		Gesamtlänge		Preis mit IK
	d(h6)	L2	L	L	L		
5 BIS 6 MM	6	44	82	59,80 €			
6,1 BIS 8 MM	8	53	91	64,90 €			
8,1 BIS 10 MM	10	61	103	74,90 €			
10,1 BIS 12 MM	12	71	118	98,90 €			
12,5 BIS 14 MM	14	77	124	139,00 €			
14,5 BIS 16 MM	16	83	133	179,50 €			
16,5 BIS 18 MM	18	93	143	263,90 €			
18,5 BIS 20 MM	20	101	153	294,90 €			



VHM-NC ANBOHRER - TiAlN BESCHICHTET



Art. Nr.	D	d(h6)	L	L2	Preis	
3501001	AB-90°-D3,0 RT303	3	3	46	10	13,90 €
3501002	AB-90°-D4,0 RT303	4	4	62	10	13,90 €
3501003	AB-90°-D5,0 RT303	5	5	62	10	13,90 €
3501004	AB-90°-D6,0 RT303	6	6	66	15	13,90 €
3501005	AB-90°-D8,0 RT303	8	8	79	17	21,90 €
3501006	AB-90°-D10,0 RT303	10	10	89	20	27,40 €
3501007	AB-90°-D12,0 RT303	12	12	102	25	40,90 €
3501008	AB-90°-D14,0 RT303	14	14	107	30	54,90 €
3501009	AB-90°-D16,0 RT303	16	16	115	35	74,70 €
3501010	AB-90°-D20,0 RT303	20	20	131	40	123,90 €



Art. Nr.	D	d(h6)	L	L2	Preis	
3501021	AB-120°-D3,0 RT303	3	3	46	10	13,90 €
3501022	AB-120°-D4,0 RT303	4	4	62	10	13,90 €
3501023	AB-120°-D5,0 RT303	5	5	62	10	13,90 €
3501024	AB-120°-D6,0 RT303	6	6	66	15	13,90 €
3501025	AB-120°-D8,0 RT303	8	8	79	17	21,90 €
3501026	AB-120°-D10,0 RT303	10	10	89	20	27,40 €
3501027	AB-120°-D12,0 RT303	12	12	102	25	40,90 €
3501028	AB-120°-D14,0 RT303	14	14	107	30	54,90 €
3501029	AB-120°-D16,0 RT303	16	16	115	35	74,70 €
3501030	AB-120°-D20,0 RT303	20	20	131	40	123,90 €

VBH-High-Feed-Bohrer

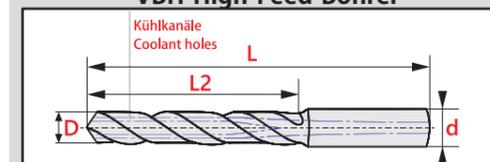

VHM-NC-Anbohrer

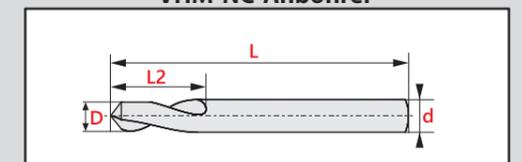

VHM-BOHRER FÜR NE-METALLE

VBA-BOHRER 3xD FÜR NE-METALLE

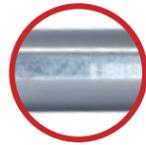

Zylinderschaft



N

BohrØ = Schaft Ø	Spirallänge	Gesamtlänge	
D = d	L2	L	
2 MM	12	38	6,95 €
2,5 MM	14	43	6,95 €
2,8 - 3 MM	16	46	6,95 €
3,1 - 3,3 MM	18	49	6,95 €
3,4 - 3,7 MM	20	52	6,95 €
3,8 - 4,0 MM	22	55	6,95 €
4,1 - 4,2 MM	22	55	7,90 €
4,3 - 4,7 MM	24	58	7,90 €
4,8 - 5,0 MM	26	62	7,90 €
5,1 - 5,3 MM	26	62	8,90 €
5,4 - 6 MM	28	66	12,10 €
6,1 - 6,4 MM	31	70	12,10 €
6,5 - 7,0 MM	34	74	17,80 €
7,1 - 7,5 MM	34	74	20,40 €
7,6 - 8,0 MM	37	79	20,40 €
8,1 - 8,5 MM	37	79	23,20 €
8,6 - 9,0 MM	40	84	23,20 €
9,1 - 9,5 MM	40	84	26,50 €

BohrØ = Schaft Ø	Spirallänge	Gesamtlänge	
D = d	L2	L	
9,6 - 10,0 MM	43	89	26,50 €
10,1 - 10,5 MM	43	89	30,80 €
10,7 - 11,0 MM	47	95	32,30 €
11,1 - 11,5 MM	47	95	38,50 €
12 MM	51	102	38,50 €
12,5 - 13,0 MM	51	102	46,60 €
13,1 MM	51	102	53,50 €
13,5 - 14 MM	54	107	53,50 €
14,3 - 14,5 MM	56	111	58,90 €
15 MM	56	111	65,70 €
16 MM	58	115	74,30 €

VBA-BOHRER 5xD FÜR NE-METALLE

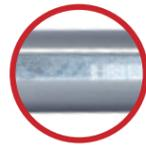

Zylinderschaft



N

BohrØ = Schaft Ø	Spirallänge	Gesamtlänge	
D = d	L2	L	
2 MM	24	49	6,50 €
2,5 MM	30	57	9,50 €
2,8 - 3 MM	33	61	9,50 €
3,5 MM	39	70	10,50 €
3,8 - 4,0 MM	43	75	10,50 €
4,2 MM	43	75	11,20 €
4,5 MM	47	80	13,60 €
4,8 - 5,0 MM	52	86	13,60 €
5,5 - 6,0 MM	57	93	17,20 €
6,5 MM	63	101	24,60 €
6,8 - 7 MM	69	109	24,60 €
7,5 MM	69	109	29,30 €
7,8 - 8,0 MM	75	117	29,30 €
8,5 MM	75	117	34,60 €

BohrØ = Schaft Ø	Spirallänge	Gesamtlänge	
D = d	L2	L	
8,8 - 9,0 MM	81	125	34,60 €
9,5 MM	81	125	38,80 €
9,8 - 10,0 MM	87	133	42,10 €
10,5 MM	87	133	49,90 €
10,8 - 11,0 MM	94	142	49,90 €
11,5 MM	94	142	63,30 €
12,0 MM	101	151	63,30 €
12,5 - 13,0 MM	101	151	79,00 €
13,5 MM	108	160	86,30 €
14,0 MM	108	160	95,50 €
14,5 MM	114	169	109,90 €
15,0 MM	114	169	116,90 €
15,5 MM	120	178	116,90 €
16 MM	120	178	134,40 €

VHM-Bohrer für NE-Metalle

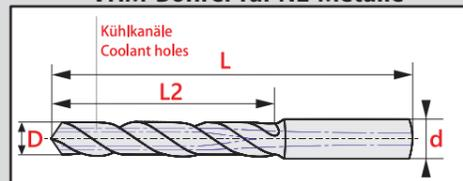

P Stahl
 M Edelstahl
 K Guss
 S Sonderwerkstoffe
 H Harte Werkstoffe
 N NE-Metalle

Komplette Träger-Zubehörliste mit Art. Nr. und Preise auf Seite 81.

VHM-BOHRER FÜR NE-METALLE MIT IK

VBA-BOHRER 3xD FÜR NE-METALLE



mit IK

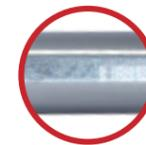

Zylinderschaft



N

BohrØ	Schaft Ø	Spirallänge	Gesamtlänge	
D	d(h6)	L2	L	
3,0 - 3,7 MM	6	20	62	33,60 €
3,8 - 4,7 MM	6	24	66	33,60 €
4,8 - 6,0 MM	6	28	66	33,60 €
6,1 - 7,0 MM	8	34	79	46,00 €
7,1 - 8,0 MM	8	41	79	46,00 €
8,1 - 10 MM	10	47	89	49,90 €

BohrØ	Schaft Ø	Spirallänge	Gesamtlänge	
D	d(h6)	L2	L	
10,1 - 12,0 MM	12	55	102	65,90 €
12,5 - 14,0 MM	14	60	107	92,90 €
14,5 - 16,0 MM	16	65	115	111,50 €
16,5 - 18,0 MM	18	73	123	184,90 €
18,5 - 20 MM	20	79	131	199,00 €

VBA-BOHRER 5xD FÜR NE-METALLE



mit IK

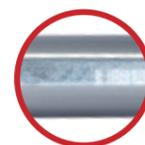

Zylinderschaft



N

BohrØ	Schaft Ø	Spirallänge	Gesamtlänge	
D	d(h6)	L2	L	
3,0 - 3,7 MM	6	28	66	42,90 €
3,8 - 4,7 MM	6	36	74	42,90 €
4,8 - 6,0 MM	6	44	82	42,90 €
6,1 - 8,0 MM	8	53	91	47,80 €
8,1 - 10 MM	10	61	103	55,20 €

BohrØ	Schaft Ø	Spirallänge	Gesamtlänge	
D	d(h6)	L2	L	
10,1 - 12,0 MM	12	71	118	77,70 €
12,5 - 14,0 MM	14	77	124	101,90 €
14,5 - 16,0 MM	16	83	133	129,90 €
16,5 - 18,0 MM	18	93	143	195,50 €
18,5 - 20 MM	20	101	153	202,90 €

VBA-BOHRER 8xD FÜR NE-METALLE



mit IK

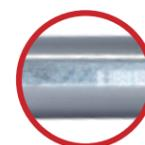

Zylinderschaft



N

BohrØ	Schaft Ø	Spirallänge	Gesamtlänge	
D	d(h6)	L2	L	
3,0 - 3,7 MM	6	34	72	86,50 €
3,8 - 4,7 MM	6	43	81	86,50 €
4,8 - 6,0 MM	6	57	95	86,50 €
6,1 - 7,0 MM	8	76	114	95,90 €

BohrØ	Schaft Ø	Spirallänge	Gesamtlänge	
D	d(h6)	L2	L	
7,1 - 8,0 MM	8	76	114	95,90 €
8,1 - 10 MM	10	95	142	111,50 €
10,1 - 12,0 MM	12	114	162	148,90 €
12,5 - 14,0 MM	14	133	178	175,90 €

VHM-FLACHBOHRER MIT 180° UND ZYLINDERSCHAFT



P M K

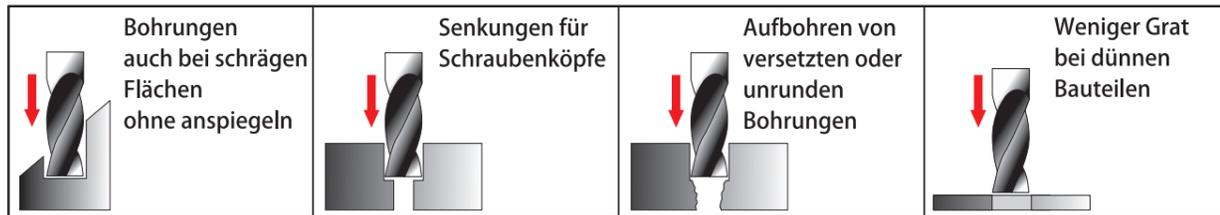

2xD

D	SchaftØ d2(h6)	L	L2	
3 - 3,3 mm	6	50	16	25,10 €
3,4 - 4,0 mm	6	50	18	25,10 €
4,1 - 4,4 mm	6	60	20	25,10 €
4,5 - 5,0 mm	6	60	22	25,10 €
5,1 - 5,6 mm	6	60	24	25,10 €
5,7 - 6,0 mm	6	60	26	25,10 €
6,1 - 6,3 mm	8	70	28	36,60 €
6,4 - 7,0 mm	8	70	30	36,60 €
7,1 - 8,0 mm	8	70	34	36,60 €
8,1 - 8,6 mm	10	80	38	44,70 €
8,7 - 9,0 mm	10	80	40	44,70 €
9,1 - 9,6 mm	10	80	42	44,70 €
9,7 - 10 mm	10	80	45	44,70 €

D	SchaftØ d2(h6)	L	L2	
10,1 - 10,3 mm	12	90	46	59,20 €
10,4 - 11 mm	12	90	48	59,20 €
11,1 - 11,6 mm	12	90	50	59,20 €
11,7 - 12 mm	12	90	52	59,20 €
12,5 mm	14	100	54	86,00 €
13,0 mm	14	100	56	86,00 €
13,5 - 14,0 mm	14	100	58	86,00 €
14,5 - 15,0 mm	16	105	62	114,50 €
15,5 - 16,0 mm	16	115	64	114,50 €
16,5 - 18,0 mm	18	125	70	144,90 €
18,5 - 19,0 mm	20	135	75	153,90 €
19,5 - 20,0 mm	20	145	75	153,90 €

5xD MIT IK

D	SchaftØ d2(h6)	L	L2	
3 - 3,7 mm	6	66	28	58,60 €
3,8 - 4,7 mm	6	74	36	58,60 €
4,8 - 6,0 mm	6	82	44	58,60 €
6,1 - 8,0 mm	8	91	53	62,40 €
8,1 - 10 mm	10	103	61	71,90 €
10,2 - 12 mm	12	118	71	89,90 €
12,5 - 14 mm	14	124	77	123,90 €
14,5 - 16,0 mm	16	133	83	162,90 €
16,5 - 18,0 mm	18	143	93	229,00 €
18,5 - 20 mm	20	153	101	255,00 €

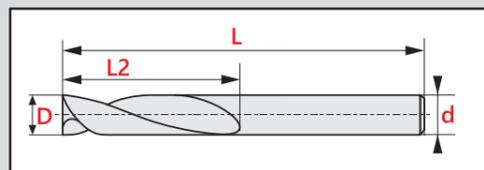

P Stahl M Edelstahl K Guss S Sonderwerkstoffe H Harte Werkstoffe N NE-Metalle
 Komplette Träger-Zubehörliste mit Art. Nr. und Preise auf Seite 81.

HSS-E-GEWINDEBOHRER - METRISCHE GEWINDE

- HSS-E -SACKLOCH - METRISCHE GEWINDE 60°



TIN P M K N

Art. Nr.	Gewinde/D	P	L2	L	L4	d	Z	Kernloch		
3301004	GB-S-ISO-M3-HSS-E-TIN	M3	0,5	6	56	18	3,5	3	2,5	10,90 €
3301006	GB-S-ISO-M4-HSS-E-TIN	M4	0,7	7	63	21	4,5	3	3,3	10,90 €
3301008	GB-S-ISO-M5-HSS-E-TIN	M5	0,8	8	70	25	6	3	4,2	10,90 €
3301009	GB-S-ISO-M6-HSS-E-TIN	M6	1	10	80	30	6	3	5	10,90 €
3301010	GB-S-ISO-M8-HSS-E-TIN	M8	1,25	13	90	35	8	3	6,8	14,90 €
3301011	GB-S-ISO-M10-HSS-E-TIN	M10	1,5	15	100	39	10	3	8,5	17,80 €
3301012	GB-S-ISO-M12-HSS-E-TIN	M12	1,75	18	110	44	9	3	10,2	23,60 €
3301014	GB-S-ISO-M16-HSS-E-TIN	M16	2	20	110	44	12	3	14	33,90 €
3301015	GB-S-ISO-M20-HSS-E-TIN	M20	2,5	25	140	54	16	4	17,5	51,50 €
3301016	GB-S-ISO-M24-HSS-E-TIN	M24	3	30	160	60	18	4	21	69,20 €
3301017	GB-S-ISO-M30-HSS-E-TIN	M30	3,5	35	180	70	22	4	26,5	124,90 €

- HSS-E - DURCHGANGSLOCH - METRISCHE GEWINDE 60°



TIN P M K N

Art. Nr.	Gewinde/D	P	L2	L	L4	d	Z	Kernloch		
3301054	GB-D-ISO-M3-HSS-E-TIN	M3	0,5	11	56	18	3,5	3	2,5	10,90 €
3301056	GB-D-ISO-M4-HSS-E-TIN	M4	0,7	13	63	21	4,5	3	3,3	10,90 €
3301058	GB-D-ISO-M5-HSS-E-TIN	M5	0,8	15	70	25	6	3	4,2	10,90 €
3301059	GB-D-ISO-M6-HSS-E-TIN	M6	1	17	80	30	6	3	5	10,90 €
3301060	GB-D-ISO-M8-HSS-E-TIN	M8	1,25	20	90	35	8	3	6,8	14,90 €
3301061	GB-D-ISO-M10-HSS-E-TIN	M10	1,5	22	100	39	10	3	8,5	17,80 €
3301062	GB-D-ISO-M12-HSS-E-TIN	M12	1,75	24	110	44	9	3	10,2	23,60 €
3301064	GB-D-ISO-M16-HSS-E-TIN	M16	2	27	110	44	12	3	14	33,90 €
3301065	GB-D-ISO-M20-HSS-E-TIN	M20	2,5	32	140	54	16	4	17,5	51,50 €
3301066	GB-D-ISO-M24-HSS-E-TIN	M24	3	34	160	60	18	4	21	69,20 €
3301067	GB-D-ISO-M30-HSS-E-TIN	M30	3,5	40	180	70	22	4	26,5	124,90 €

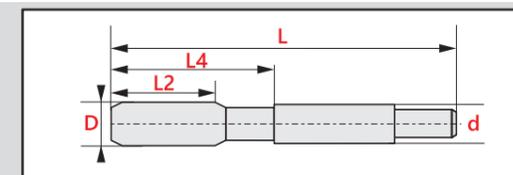

HSS-E-GEWINDEBOHRER - METRISCHE FEINGEWINDE

- HSS-E - SACKLOCH - METRISCHE FEINGEWINDE 60°



TIN P M K N

Art. Nr.	Gewinde/D	L2	L	L4	d	Z	Kernloch		
3301341	GB-S-ISO-M4x0,5-6H-TiALN	M4x0,5	5	63	21	2,8	3	3,5	16,70 €
3301342	GB-S-ISO-M5x0,5-6H-TiALN	M5x0,5	5	70	25	3,5	3	4,5	16,70 €
3301343	GB-S-ISO-M6x0,75-6H-TiALN	M6x0,75	8	80	30	4,5	3	5,2	16,70 €
3301344	GB-S-ISO-M6x0,5-6H-TiALN	M6x0,5	5	80	30	4,5	3	5,5	16,70 €
3301345	GB-S-ISO-M8x1-6H-TiALN	M8x1	10	90	36	6	3	7	19,60 €
3301346	GB-S-ISO-M8x0,75-6H-TiALN	M8x0,75	8	80	30	6	3	7,25	19,60 €
3301347	GB-S-ISO-M10x1,25-6H-TiALN	M10x1,25	16	100	40	7	3	8,8	22,40 €
3301348	GB-S-ISO-M10x1-6H-TiALN	M10x1	10	90	36	7	3	9	22,40 €
3301349	GB-S-ISO-M10x0,75-6H-TiALN	M10x0,75	10	90	36	7	3	9,25	26,80 €
3301350	GB-S-ISO-M12x1,5-6H-TiALN	M12x1,5	15	100	40	9	3	10,5	27,20 €
3301351	GB-S-ISO-M12x1,25-6H-TiALN	M12x1,25	15	100	40	9	3	10,8	27,20 €
3301352	GB-S-ISO-M12x1-6H-TiALN	M12x1	11	100	40	9	3	11	27,20 €
3301353	GB-S-ISO-M16x1,5-6H-TiALN	M16x1,5	15	100	40	12	3	14,5	41,40 €
3301354	GB-S-ISO-M16x1-6H-TiALN	M16x1	12	100	40	12	3	15	41,40 €
3301355	GB-S-ISO-M20x1,5-6H-TiALN	M20x1,5	17	125	50	16	4	18,5	55,50 €
3301356	GB-S-ISO-M24x2,0-6H-TiALN	M24x2,0	20	140	54	18	4	22	73,90 €
3301357	GB-S-ISO-M24x1,5-6H-TiALN	M24x1,5	20	140	54	18	4	22,5	71,30 €

- HSS-E - DURCHGANGLÖCH - METRISCHE FEINGEWINDE 60°



TIN P M K N

Art. Nr.	Gewinde/D	L2	L	L4	d	Z	Kernloch		
3301321	GB-D-ISO-M4x0,5-6H-TiALN	M4x0,5	10	63	21	2,8	3	3,5	16,70 €
3301322	GB-D-ISO-M5x0,5-6H-TiALN	M5x0,5	11	70	25	3,5	3	4,5	16,70 €
3301323	GB-D-ISO-M6x0,75-6H-TiALN	M6x0,75	13	80	30	4,5	3	5,2	16,70 €
3301324	GB-D-ISO-M6x0,5-6H-TiALN	M6x0,5	13	80	30	4,5	3	5,5	16,70 €
3301325	GB-D-ISO-M8x1-6H-TiALN	M8x1	17	90	36	6	3	7	19,60 €
3301326	GB-D-ISO-M8x0,75-6H-TiALN	M8x0,75	14	80	30	6	3	7,25	19,60 €
3301327	GB-D-ISO-M10x1,25-6H-TiALN	M10x1,25	22	100	40	7	3	8,8	22,40 €
3301328	GB-D-ISO-M10x1-6H-TiALN	M10x1	18	90	36	7	3	9	22,40 €
3301329	GB-D-ISO-M10x0,75-6H-TiALN	M10x0,75	18	90	36	7	3	9,25	26,80 €
3301330	GB-D-ISO-M12x1,5-6H-TiALN	M12x1,5	22	100	40	9	3	10,5	27,20 €
3301331	GB-D-ISO-M12x1,25-6H-TiALN	M12x1,25	22	100	40	9	3	10,8	27,20 €
3301332	GB-D-ISO-M12x1-6H-TiALN	M12x1	18	100	40	9	3	11	27,20 €
3301333	GB-D-ISO-M16x1,5-6H-TiALN	M16x1,5	22	100	40	12	3	14,5	41,40 €
3301334	GB-D-ISO-M16x1-6H-TiALN	M16x1	18	100	40	12	3	15	41,40 €
3301335	GB-D-ISO-M20x1,5-6H-TiALN	M20x1,5	25	125	50	16	4	18,5	55,50 €
3301336	GB-D-ISO-M24x2,0-6H-TiALN	M24x2,0	27	140	54	18	4	22	73,90 €
3301337	GB-D-ISO-M24x1,5-6H-TiALN	M24x1,5	27	140	54	18	4	22,5	71,30 €

P Stahl M Edelstahl K Guss S Sonderwerkstoffe H Harte Werkstoffe N NE-Metalle

Komplette Träger-Zubehörliste mit Art. Nr. und Preise auf Seite 81.

HSS-PM-GEWINDEBOHRER - METRISCHE GEWINDE

- Pulvermetallurgischer Schnellarbeitsstahl für hohe Schneidkantenstabilität.
- Reduzierte Schnittkräfte durch optimierte Schneidengeometrie
- Verschleiß- und hitzebeständige TiAlN-Beschichtung

- HSS-PM - SACKLOCH - METRISCHE GEWINDE 60°



TiAlN P M K N

Art. Nr.	Gewinde/D	P	L2	L	L4	d	Z	Kernloch		
3301121	GB-S-M2-HSS-PM-TiALN	M2	0,4	3,2	45,0	13,0	2,8	2	1,6	20,90 €
3301122	GB-S-M2,5-HSS-PM-TiALN	M2,5	0,45	3,6	50,0	15,0	2,8	2	2,1	17,50 €
3301123	GB-S-M3-HSS-PM-TiALN	M3	0,5	4,0	56,0	18,0	3,5	3	2,5	14,40 €
3301124	GB-S-M3,5-HSS-PM-TiALN	M3,5	0,6	4,8	56,0	20,0	4,0	3	2,9	15,90 €
3301125	GB-S-M4-HSS-PM-TiALN	M4	0,7	5,6	63,0	21,0	4,5	3	3,3	15,40 €
3301126	GB-S-M5-HSS-PM-TiALN	M5	0,8	6,4	70	25,0	6,0	3	4,2	15,40 €
3301127	GB-S-M6-HSS-PM-TiALN	M6	1,0	8,0	80	30,0	6,0	3	5	15,40 €
3301128	GB-S-M8-HSS-PM-TiALN	M8	1,25	13,0	90	35,0	8,0	3	6,8	20,90 €
3301129	GB-S-M10-HSS-PM-TiALN	M10	1,5	15,0	100	39,0	10,0	3	8,5	26,20 €
3301130	GB-S-M12-HSS-PM-TiALN	M12	1,75	18,0	110	44,0	9,0	3	10,2	34,70 €
3301131	GB-S-M14-HSS-PM-TiALN	M14	2,0	20,0	110	44,0	11,0	3	12	38,90 €
3301132	GB-S-M16-HSS-PM-TiALN	M16	2,0	20,0	110	44,0	12,0	3	14	49,90 €
3301133	GB-S-M18-HSS-PM-TiALN	M18	2,5	25,0	125	50,0	14,0	4	15,5	67,20 €
3301134	GB-S-M20-HSS-PM-TiALN	M20	2,5	25,0	140	54,0	16,0	4	17,5	72,50 €
3301135	GB-S-M22-HSS-PM-TiALN	M22	2,5	25,0	140	54,0	18,0	4	19,5	90,50 €
3301136	GB-S-M24-HSS-PM-TiALN	M24	3,0	30,0	160	60,0	18,0	4	21	108,20 €

- HSS-PM - DURCHGANGLÖCH - METRISCHE GEWINDE 60°



TiAlN P M K N

Art. Nr.	Gewinde/D	P	L2	L	L4	d	Z	Kernloch		
3301151	GB-D-M2-HSS-PM-TiALN	M2	0,4	8,0	45,0	13,0	2,8	2	1,6	20,90 €
3301152	GB-D-M2,5-HSS-PM-TiALN	M2,5	0,45	9,0	50,0	15,0	2,8	2	2,1	17,50 €
3301153	GB-D-M3-HSS-PM-TiALN	M3	0,5	11,0	56,0	18,0	3,5	3	2,5	14,40 €
3301154	GB-D-M3,5-HSS-PM-TiALN	M3,5	0,6	12,0	56,0	20,0	4,0	3	2,9	15,90 €
3301155	GB-D-M4-HSS-PM-TiALN	M4	0,7	13,0	63,0	21,0	4,5	3	3,3	15,40 €
3301156	GB-D-M5-HSS-PM-TiALN	M5	0,8	15,0	70	25,0	6,0	3	4,2	15,40 €
3301157	GB-D-M6-HSS-PM-TiALN	M6	1,0	17,0	80	30,0	6,0	3	5	15,40 €
3301158	GB-D-M8-HSS-PM-TiALN	M8	1,25	20,0	90	35,0	8,0	3	6,8	20,90 €
3301159	GB-D-M10-HSS-PM-TiALN	M10	1,5	22,0	100	39,0	10,0	3	8,5	26,20 €
3301160	GB-D-M12-HSS-PM-TiALN	M12	1,75	24,0	110	44,0	9,0	3	10,2	34,70 €
3301161	GB-D-M14-HSS-PM-TiALN	M14	2,0	26,0	110	44,0	11,0	3	12	38,90 €
3301162	GB-D-M16-HSS-PM-TiALN	M16	2,0	27,0	110	44,0	12,0	3	14	49,90 €
3301163	GB-D-M18-HSS-PM-TiALN	M18	2,5	30,0	125	50,0	14,0	3	15,5	67,20 €
3301164	GB-D-M20-HSS-PM-TiALN	M20	2,5	32,0	140	54,0	16,0	3	17,5	72,50 €
3301165	GB-D-M22-HSS-PM-TiALN	M22	2,5	32,0	140	54,0	18,0	3	19,5	90,50 €
3301166	GB-D-M24-HSS-PM-TiALN	M24	3,0	34,0	160	60,0	18,0	3	21	108,20 €

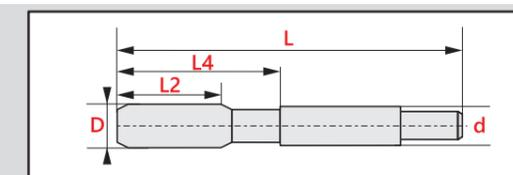

HSS-E-GEWINDEBOHRER - NE-METALLE

- HSS-E - SACKLOCH - METRISCHE GEWINDE - FÜR NE-METALLE 60°



BLANK

N

Art. Nr.	Gewinde/D	P	L2	L	L4	d	Z	Kernloch		
3301291	GB-S-M2-6H-HSS-E-ALU	M2	0,4	8	45	13	2,8	2	1,6	12,10 €
3301292	GB-S-M2,5-6H-HSS-E-ALU	M2,5	0,45	9	50	15	2,8	2	2,1	9,90 €
3301293	GB-S-M3-6H-HSS-E-ALU	M3	0,5	6	56	18	3,5	2	2,5	8,30 €
3301294	GB-S-M3,5-6H-HSS-E-ALU	M3,5	0,6	7	56	20	4	2	2,9	8,90 €
3301295	GB-S-M4-6H-HSS-E-ALU	M4	0,7	7	63	21	4,5	2	3,3	8,30 €
3301296	GB-S-M4,5-6H-HSS-E-ALU	M4,5	0,75	8	70	25	6	2	3,7	8,50 €
3301297	GB-S-M5-6H-HSS-E-ALU	M5	0,8	8	70	25	6	2	4,2	8,50 €
3301298	GB-S-M6-6H-HSS-E-ALU	M6	1,0	10	80	30	6	2	5	8,50 €
3301299	GB-S-M8-6H-HSS-E-ALU	M8	1,25	13	90	35	8	2	6,8	10,50 €
3301300	GB-S-M10-6H-HSS-E-ALU	M10	1,5	15	100	39	10	2	8,5	12,60 €
3301301	GB-S-M12-6H-HSS-E-ALU	M12	1,75	18	110	44	9	2	10,2	16,90 €
3301302	GB-S-M14-6H-HSS-E-ALU	M14	2,0	20	110	44	11	3	12	22,90 €
3301303	GB-S-M16-6H-HSS-E-ALU	M16	2,0	20	110	44	12	3	14	25,90 €
3301304	GB-S-M18-6H-HSS-E-ALU	M18	2,5	25	125	50	14	3	15,5	37,50 €
3301305	GB-S-M20-6H-HSS-E-ALU	M20	2,5	25	140	54	16	3	17,5	44,90 €
3301306	GB-S-M22-6H-HSS-E-ALU	M22	2,5	25	140	54	18	3	19,5	51,90 €
3301307	GB-S-M24-6H-HSS-E-ALU	M24	3,0	30	160	60	18	3	21	59,90 €
3301308	GB-S-M30-6H-HSS-E-ALU	M30	3,5	35	180	70	22	3	26,5	101,50 €

- HSS-E - DURCHGANGSLOCH - METRISCHE GEWINDE - FÜR NE-METALLE 60°



BLANK

N

Art. Nr.	Gewinde/D	P	L2	L	L4	d	Z	Kernloch		
3301271	GB-D-M2-6H-HSS-E-ALU	M2	0,4	8	45	13	2,8	3	1,6	11,50 €
3301272	GB-D-M2,2-6H-HSS-E-ALU	M2,2	0,45	8	45	13	2,8	3	1,8	13,70 €
3301273	GB-D-M2,5-6H-HSS-E-ALU	M2,5	0,45	9	50	15	2,8	3	2,1	10,50 €
3301274	GB-D-M3-6H-HSS-E-ALU	M3	0,5	11	56	18	3,5	3	2,5	8,30 €
3301275	GB-D-M3,5-6H-HSS-E-ALU	M3,5	0,6	12	56	20	4	3	2,9	9,50 €
3301276	GB-D-M4-6H-HSS-E-ALU	M4	0,7	13	63	21	4,5	3	3,3	8,30 €
3301277	GB-D-M4,5-6H-HSS-E-ALU	M4,5	0,75	14	70	25	6	3	3,7	8,30 €
3301278	GB-D-M5-6H-HSS-E-ALU	M5	0,8	15	70	25	6	3	4,2	8,30 €
3301279	GB-D-M6-6H-HSS-E-ALU	M6	1,0	17	80	30	6	3	5	8,50 €
3301280	GB-D-M8-6H-HSS-E-ALU	M8	1,25	20	90	35	8	3	6,8	10,90 €
3301281	GB-D-M10-6H-HSS-E-ALU	M10	1,5	22	100	39	10	3	8,5	13,70 €
3301282	GB-D-M12-6H-HSS-E-ALU	M12	1,75	24	110	44	9	3	10,2	16,90 €
3301283	GB-D-M14-6H-HSS-E-ALU	M14	2,0	26	110	44	11	3	12	19,90 €
3301284	GB-D-M16-6H-HSS-E-ALU	M16	2,0	27	110	44	12	3	14	25,50 €

P Stahl M Edelstahl K Guss S Sonderwerkstoffe H Harte Werkstoffe N NE-Metalle

Komplette Träger-Zubehörliste mit Art. Nr. und Preise auf Seite 81.

HSS-E-GEWINDEBOHRER - ZÖLLIGE GEWINDE

- HSS-E - SACKLOCH - ZÖLLIGE GEWINDE 55°



VAP

P M

Art. Nr.	Gewinde	L2	L	L4	d	D	Z	Kernloch		
3301101	GB-S-G1/8-HSS-E	G1/8	20,0	90	36	7,0	8,8	3	8,8 mm	21,90 €
3301102	GB-S-G1/4-HSS-E	G1/4	22,0	100	40	11,0	11,8	3	11,8 mm	29,30 €
3301103	GB-S-G3/8-HSS-E	G3/8	22,0	100	40	12,0	15,25	3	15,25 mm	38,80 €
3301104	GB-S-G1/2-HSS-E	G1/2	25,0	125	50	16,0	19	4	19 mm	45,90 €
3301105	GB-S-G3/4-HSS-E	G3/4	28,0	140	54	20,0	24,5	4	24,5 mm	79,80 €
3301106	GB-S-G1-HSS-E	G1	30,0	160	60	25,0	30,75	4	30,75 mm	108,90 €

- HSS-E - DURCHGANGSLOCH - ZÖLLIGE GEWINDE 55°



BLANK

P K N

Art. Nr.	Gewinde	L2	L	L4	d	D	Z	Kernloch		
3301261	GB-D-G1/8-HSS-E	G1/8	20,0	90	36	7,0	8,8	3	8,8 mm	16,70 €
3301262	GB-D-G1/4-HSS-E	G1/4	22,0	100	40	11,0	11,8	3	11,8 mm	21,90 €
3301263	GB-D-G3/8-HSS-E	G3/8	22,0	100	40	12,0	15,25	3	15,25 mm	25,80 €
3301264	GB-D-G1/2-HSS-E	G1/2	25,0	125	50	16,0	19	4	19 mm	37,40 €
3301265	GB-D-G3/4-HSS-E	G3/4	28,0	140	54	20,0	24,5	4	24,5 mm	66,90 €
3301266	GB-D-G1-HSS-E	G1	30,0	160	60	25,0	30,75	4	30,75 mm	91,90 €

Kernlochmaß-Tabelle für Gewindebohrer

Metrisch				Metrische Feingewinde				Zöllig	
Gew.	Kernloch	Gew.	Kernloch	Gew.	Kernloch	Gew.	Kernloch	Gew.	Kernloch
M1	0,75 mm	M10	8,5 mm	1,0x0,20	0,78 mm	12x1,50	10,50 mm	G1/8"	8,8 mm
M1,1	0,85 mm	M12	10,2 mm	2,0x0,25	1,75 mm	14x1,00	13,00 mm	G1/4"	11,8 mm
M1,2	0,95 mm	M14	12 mm	2,5x0,35	2,15 mm	14x1,50	12,50 mm	G3/8"	15,25 mm
M1,4	1,1 mm	M16	14 mm	3x0,25	2,75 mm	15x1,50	13,50 mm	G1/2"	19 mm
M1,6	1,3 mm	M18	15,5 mm	4x0,35	3,65 mm	16x1,00	15,00 mm	G5/8"	21 mm
M1,8	1,5 mm	M20	17,5 mm	4x0,5	3,5 mm	16x1,50	14,50 mm	G3/4"	24,5 mm
M2	1,6 mm	M22	19,5 mm	5x0,50	4,50 mm	18x1,50	16,50 mm	G1"	30,75 mm
M2,2	1,8 mm	M24	21 mm	6x0,50	5,50 mm	20x1,50	18,50 mm	G1 1/4"	39,25 mm
M2,5	2,1 mm	M27	24 mm	6x0,75	5,25 mm	20x2,00	18,00 mm	G1 1/2"	42,25 mm
M3	2,5 mm	M30	26,5 mm	8x0,75	7,25 mm	22x1,50	20,50 mm	G2"	57 mm
M3,5	2,9 mm	M33	29,5 mm	8x1,00	7,00 mm	24x1,50	22,50 mm	G2 1/2"	72,6 mm
M4	3,3 mm	M36	32 mm	10x0,75	9,25 mm	24x2,00	22,00 mm	G3"	85,3 mm
M4,5	3,3 mm	M42	37,5 mm	10x1,00	9,00 mm	27x1,50	25,50 mm	G3 1/2"	97,7 mm
M5	4,2 mm	M48	43 mm	10x1,25	8,80 mm	28x2,00	26,00 mm	G4"	110,4 mm
M6	5 mm	M56	50,5 mm	12x1,00	11,00 mm	30x2,00	28,00 mm		
M8	6,8 mm	M64	58 mm	12x1,25	10,80 mm				

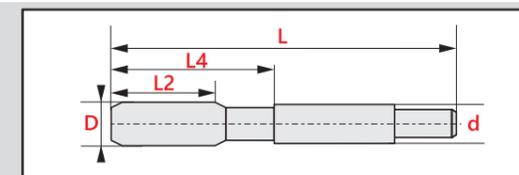

EINSATZEMPFEHLUNG VBU-BOHRER



ISO Gruppe	Werkstoff	V _c (m/min)	Vorschubfaktor F _m		
			3xD & 5xD	8xD	10xD & 12xD
P	Stahl niedriglegiert	180	0,015	0,013	0,012
P	Stahl hochlegiert	120	0,012	0,01	0,01
M	Nichtrostende Stähle	80	0,01	0,008	0,007
K	Gusseisen	250	0,018	0,015	0,014
K	Stahlguss	180	0,015	0,012	0,012
N	Aluminium	400	0,02	0,018	0,018

Formeln

$$Drehzahl (n) = \frac{V_c}{\pi \times D}$$

$$Vorschub/Umdrehung (f_n) = F_m \times D$$

$$Vorschubgeschw. (V_f) = n \times f_n$$

Beispiel

Bohrer Ø 10 mm
Werkstoff Stahl niedriglegiert 42CrMo4

$$n = \frac{180 \text{ m/min}}{\pi \times 0,01 \text{ m}} = 5730 \text{ 1/min}$$

$$f_n = 0,015 \times 10 \text{ mm} = 0,15 \text{ mm}$$

$$V_f = 5730 \text{ 1/min} \times 0,15 \text{ mm} = 860 \text{ mm/min}$$

EINSATZEMPFEHLUNG VBS-BOHRER



ISO Gruppe	Werkstoff	V _c (m/min)	Vorschubfaktor F _m
M	Nichtrostende Stähle	80	0,02
S	Ni- /Co-Basislegierungen	40	0,01
S	Titanlegierungen	60	0,012

Formeln

$$Drehzahl (n) = \frac{V_c}{\pi \times D}$$

$$Vorschub/Umdrehung (f_n) = F_m \times D$$

$$Vorschubgeschw. (V_f) = n \times f_n$$

Beispiel

Bohrer Ø 10 mm
Werkstoff Nichtrostende Stahl

$$n = \frac{80 \text{ m/min}}{\pi \times 0,01 \text{ m}} = 2547 \text{ 1/min}$$

$$f_n = 0,02 \times 10 \text{ mm} = 0,2 \text{ mm}$$

$$V_f = 2547 \text{ 1/min} \times 0,2 \text{ mm} = 509 \text{ mm/min}$$

EINSATZEMPFEHLUNG VBA-BOHRER



ISO Gruppe	Werkstoff	V _c (m/min)	Vorschubfaktor F _m
N	Alu-Knetlegierungen	180	0,02
N	Alu-Gusslegierungen	130	0,02
N	Kupfer/Kupferlegierungen	130	0,02

Formeln

$$Drehzahl (n) = \frac{V_c}{\pi \times D}$$

$$Vorschub/Umdrehung (f_n) = F_m \times D$$

$$Vorschubgeschw. (V_f) = n \times f_n$$

Beispiel

Bohrer Ø 10 mm
Werkstoff Alu-Knetlegierung

$$n = \frac{180 \text{ m/min}}{\pi \times 0,01 \text{ m}} = 5729 \text{ 1/min}$$

$$f_n = 0,02 \times 10 \text{ mm} = 0,2 \text{ mm}$$

$$V_f = 5729 \text{ 1/min} \times 0,2 \text{ mm} = 1145 \text{ mm/min}$$

EINSATZEMPFEHLUNG VBH-BOHRER



ISO	Werkstoff	V _c (m/min)	Parameter	Ø: 5,0-5,9	Ø: 6,0-7,9	Ø: 8,0-9,9	Ø: 10,0-11,9	Ø: 12,0-13,9	Ø: 14,0-15,9	Ø: 16,0-17,9	Ø: 18,0-19,9	Ø: 20,0
P	Unlegierter Stahl	80-135	mm/U	0,16-0,25	0,20-0,30	0,26-0,38	0,34-0,48	0,41-0,55	0,47-0,65	0,47-0,68	0,50-0,75	0,54-0,80
	Niedrig legierter Stahl	80-135	mm/U	0,16-21,0	0,20-0,26	0,26-0,34	0,34-0,42	0,41-0,47	0,47-0,54	0,47-0,55	0,50-0,59	0,54-0,67
	Hochlegierter- & Werkzeugstahl	70-110	mm/U	0,13-0,18	0,16-0,22	0,21-0,29	0,26-0,36	0,32-0,38	0,36-0,43	0,36-0,45	0,38-0,47	0,41-0,54
K	Gusseisen	80-135	mm/U	0,23-0,30	0,27-0,36	0,36-0,48	0,45-0,60	0,54-0,72	0,63-0,84	0,64-0,80	0,72-0,90	0,80-0,98
	Stahlguss	90-120	mm/U	0,20-0,25	0,24-0,30	0,32-0,40	0,40-0,50	0,48-0,60	0,56-0,70	0,56-0,72	0,63-0,81	0,70-0,90

MESSMITTEL

IP67 WASSERDICHTER DIGITALER MESSSCHIEBER



Digitaler Messschieber mit großem Display. Unempfindlich gegen Staub, Wasser und Öl.

Ableseung: 0,01/0,0005"/1/128"

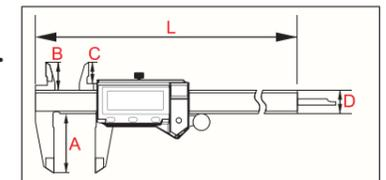

Art. Nr.	Messbereich	Genauigkeit	A	B	C	D	L		
2015-1005-A	0-150	0-150/0-6"	0,02/0,001"	40	20	15,5	16	235	69,00 €
2015-1015-A	0-300	0-300/0-12"	0,03/0,0015"	60	26	21,5	16	390	107,00 €

IP67 WASSERDICHTER DIGITALER TIEFENMESSSCHIEBER



Digitaler Tiefenmessschieber mit großem Display. Unempfindlich gegen Staub, Wasser und Öl.

Eigenschaften:

Messbereich: 0-150/0-6"

Ableseung: 0.01/0.0005"

Genauigkeit: 0.03/0.0015"

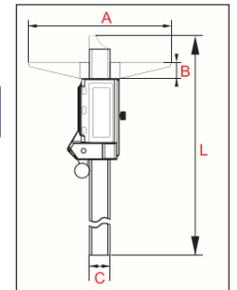

Art. Nr.	A	B	C	L	
2330-1105	100	11	14,5	232,5	69,00 €

FÜHLHEBEL - MESSGERÄT 0-0,8 MM



- Robuster, stoßfester Antrieb
- Rahmenkörper mit hervorragender Steifigkeit
- Zifferblatt mit weißem Rand für bessere Lesbarkeit
- Gehärtete und geschliffene Kontaktstelle

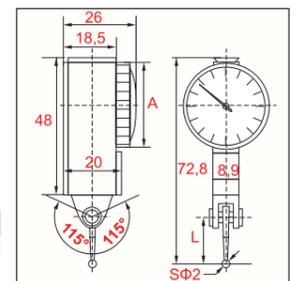

Art. Nr.	Messbereich	Abstufung	A	L	
5221-1129	0-0,8	0,01	30	16,5	47,00 €

MESSUHR 0-10



Messuhr:

- Reibungsarm gelagert, für eine höhere Empfindlichkeit und eine schnelle Reaktionsfähigkeit.
- Messstab nahezu spielfrei.

Messbereich: 0-10

Abstufung: 0.01

Typ: Flat Back

Toleranz: 0,017

Hysterese: 0.003

Art. Nr.	A	B	C	D	L	
5121-1105	8	58	8	18,5	55	36,00 €

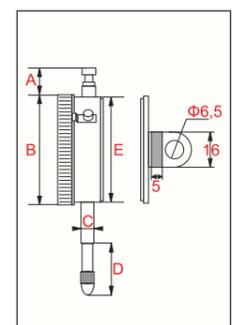

MAGNETSTATIV 290 MM / 80 Kg



Magnetstativ:

- Alle Verschleißteile bestehen aus gehärtetem Stahl mit einer Härte über 58HRC.
- Die innere Struktur besteht aus Kugellagerstahl, um eine höhere Verschleiß-festigkeit und eine längere Lebensdauer zu gewährleisten.

Magnetkraft: 80 Kg

Sockel: 60x50x55

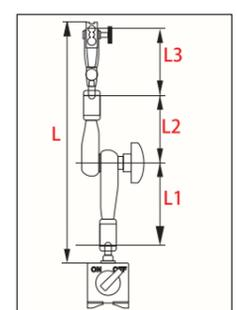

Art. Nr.	L	L1	L2	L3	
7121-0025	290	100	82	81	59,00 €

ZUBEHÖR



PLATTENSCHRAUBEN

Art. Nr.	Schlüssel	Drehmoment	
5001271	IPM 2,2x5,5	T07	0,8 Nm 1,60 €
5001231	IPM 3x9	T09	1,8 Nm 2,80 €
5001232	IPM 4x12	T15	3,4 Nm 2,80 €
5001233	IPM 1,8x4	T05	0,5 Nm 3,45 €
5001272	IPM 2,5x6,5	T07	1,0 Nm 2,80 €
5001234	IPM 2,5x6,5T	T08	1,0 Nm 2,80 €
5001242	IPM 2x4,3	T06	0,5 Nm 2,80 €
5001273	IPM 3,5x0,8TT	T10	2,7 Nm 2,90 €
5001240	IPM 3,5x10	T15	2,7 Nm 2,80 €
5001235	IPM 3x7	T10	1,8 Nm 2,80 €
5001274	IPM 4x10	T15	3,4 Nm 2,80 €
5001275	IPM 4x12	T15	3,4 Nm 2,80 €
5001249	IPM 5x11	T20	6,7 Nm 4,10 €
5001237	IPM 5x17	T20	6,7 Nm 2,80 €
5001239	IRM 4x10	T15	3,4 Nm 4,00 €
5001243	M2,2x5	T07	0,7 Nm 1,60 €
5001276	M3,5x10	T15	2,7 Nm 1,60 €
5001104	M3,5x12	T15	2,3 Nm 1,45 €
5001261	M1,6x0,4	T06	0,28 Nm 2,80 €
SM22119	SSV M2x5-9502	T06	0,6 Nm 3,20 €
SM21426	SSV M2,2x5-9503	T06	0,85 Nm 3,20 €
SM49536	SSV M2,5x5-9504	T08	1,2 Nm 2,00 €
SM39568	SSV M2,5x6-9505	T08	1,2 Nm 2,00 €
SM21402	SSV M2,5x7-9506	T08	1,2 Nm 2,00 €
SM49673	SSV M3x6-9507	T08	1,9 Nm 2,00 €
SM21464	SSV M3x8-9508	T08	1,9 Nm 2,00 €
SM27350	SSV M3,5x8-9510	T15	2,9 Nm 2,00 €
SM21433	SSV M3,5x10-9511	T15	2,9 Nm 2,00 €
SM21440	SSV M3,5x14-9512	T15	2,9 Nm 2,00 €
SM27367	SSV M3,5x8-SC-9513	T10	2,9 Nm 4,00 €
SM29897	SSV M4x10-9514	T15	4,3 Nm 2,00 €
SM21471	SSV M4x12-9515	T15	4,3 Nm 3,20 €
SM40083	SSV M4x14-9516	T15	4,3 Nm 3,20 €
SM29934	SSV M4x12x6-9517	T15	4,3 Nm 4,00 €
SM21457	SSV M4,5x11-9518	T20	5 Nm 3,20 €
SM39193	SSV M5x13-9519	T20	8,5 Nm 4,00 €
SM00470	SSV M4x9x5 - 9528	T15	4,3 Nm 2,00 €



KNIEHEBEL

Art. Nr.		
5001311	L3	5,20 €
5001312	L3B	5,20 €
SM21372	SPL1 - 9120	8,00 €
SM21389	SPL2 - 9121	8,00 €
SM27268	SPL3 - 9122	8,00 €
SM00173	SPL4 - 9123	8,00 €



KNIEHEBEL SCHRAUBEN

Art. Nr.	Schlüssel	
5001301	LEM5x12B	T09 3,80 €
5001302	LEM6x13,4A	SW2,5 3,80 €
SM22157	SLV1 M8x20 - 9224	SW3 4,80 €
SM22164	SLV2 M8x24 - 9225	SW3 4,80 €
SM22171	SLV3 M10x29 - 9226	SW4 4,80 €
SM53120	SLV4 M8x21 - 9229	SW3 4,80 €



UNTERLEGPLATTEN

Art. Nr.		
SM27343	BAX CC09 - 9616	4,90 €
SM21938	BAX CC12 - 9617	4,90 €
SM21877	BAX CN12 - 9603	4,90 €
SM21907	BAX CN16 - 9604	4,90 €
SM21914	BAX CN19 - 9605	6,80 €
SM21808	BAX DC11 - 9613	4,90 €
SM21921	BAX DN11 - 9601	4,90 €
SM21792	BAX DN15 - 9602	4,90 €
SM21822	BAX SN12 - 9608	4,90 €
SM21983	BAX TC16 - 9619	4,90 €
SM52475	BAX TEL-16 - 9626	4,90 €
SM52482	BAX TEL-22 - 9628	4,90 €
SM39223	BAX TER-16 - 9625	4,90 €
SM39230	BAX TER-22 - 9627	4,90 €
SM21884	BAX VB16 - 9618	4,90 €
SM29880	BAX VC16 - 9620	4,90 €
SM21891	BAX WN08 - 9607	2,30 €
5001281	W06AP	2,30 €



UNTERLEGPLATTENSCHRAUBEN

Art. Nr.	Schlüssel	
SM49543	SBV5 M5x0,5 A3,5x9-9408	SW3,5 2,00 €
SM22034	SBV5 M5x0,5 A3,5x11-9407	SW3,5 2,00 €
SM22041	SBV2 M6x0,75 A4x13-9410	SW4,5 3,20 €
SM22003	TSAV M4x10 - 9403	SW3 2,00 €
SM39575	TSAV M4x10x6 - 9402	SW2,5 2,00 €
SM00227	TSAV2 M4x12 - 9221	T20 2,00 €
SM00500	TSAV1 M3x9 - 9220	T15 2,00 €



UNTERLEGPLATTEN ROHRSTIFT

Art. Nr.		
SM21525	SLAY1 - 9701	1,60 €
SM26740	SLAY2 - 9702	1,60 €
SM29927	SLAY3 - 9703	1,60 €
5001291	SP3	1,60 €



PRATZEN

Art. Nr.		
SM21259	TSK1 - 9101	6,40 €
SM21297	TSK2 - 9102	5,60 €
SM49611	TSK6 - 9106	5,60 €



PRATZENSCHRAUBEN

Art. Nr.	Schlüssel	
SM49574	TSBV M5x18 - 9201	SW3 2,00 €
SM21617	TSBV M5x24 - 9202	SW3 2,00 €
SM21624	TSBV M6x30 - 9205	SW3 2,00 €



FEDERSCHEIBE FÜR PRATZENHALTER

Art. Nr.		
SM21501	TSP 6,5x10 - 9705	2,40 €

RINALDI-TOOLS SORTENBESCHREIBUNG

Cermet Unbeschichtete Cermet Sorte für die Feinstbearbeitung in Stahl und Edelstahl
HART PVD-Beschichtete Hartmetallsorte für das Hartfräsen 55-68 HRC
RT100 Unbeschichtetes K10-K15 Hartmetall für ALU und Kunststoff
RT100+ PVD-Beschichtetes K15-K20 Hartmetall für ALU und Ne-Metalle
RT102 PVD-TiAlN Beschichtetes M05-M15 Hartmetall für ALU / Edelstahl
RT103 PVD-TiAlN Beschichtetes S05-S15 Hartmetall für Sonderwerkstoffe (Inconel, Hastelloy usw.)
RT105/RT105C PVD-TiAlN Beschichtetes M10-M20 Hartmetall für ALU / Edelstahl
RT107 Die DLC-Beschichtung (Diamond-Like-Carbon) aus diamantähnlichem Kohlenstoff sorgt für einen niedrigeren Verschleiß.
RT110S PVD-TiAlN beschichtetes S10 Hartmetall für Sonderwerkstoffe
RT130S PVD-Beschichtete Spezialsorte S05-S15 für Sonderwerkstoffe (drehen)
RT150+ CVD-Beschichtetes 2-Farbig beschichtetes P10-P20 Hartmetall für Stahl
RT150K CVD-Beschichtetes K10-K20 Hartmetall für die Gussbearbeitung
RT150X PVD-Beschichtetes M10-M20 Hartmetall für das Schlichten in Edelstahl
RT200 PVD-Beschichtetes K20 Feinkorn-Hartmetall für den universellen Einsatz
RT215+ CVD-Beschichtetes P10 Hartmetall der neuesten Generation für Stahl im Vollschnitt
RT220 Unbeschichtetes K20 Hartmetallsubstrat für die Bearbeitung von NE-Metallen
RT225+ CVD-Beschichtetes P20 Hartmetall der neuesten Generation für Stahl allgem. Bearbeitung
RT250 CVD-Beschichtetes P25-TiN Hartmetall für die allg. Stahlbearbeitung
RT250+ CVD-Beschichtetes 2-Farbig beschichtetes P20-P30 Hartmetall für Stahl
RT250K CVD-Beschichtetes K25 Hartmetall für die grobe Gussbearbeitung
RT250M PVD-Beschichtetes M20-M30 Hartmetall. 1. Wahl bei Edelstahl
RT250P CVD-Beschichtete P25-TiAlN Sorte für Stahl (drehen)
RT250X PVD-Multilayer Beschichtetes P10-P30 und M10-M30 Hartmetall für die Universelle Anwendung in Stahl und Edelstahl
RT253 CVD-Beschichtetes M20-M35 Hartmetall für das Schruppen in Edelstahl
RT255M PVD-Beschichtetes M20-M30 Hartmetall. Gute Wahl bei Edelstahl
RT300 PVD-Beschichtetes P15-P25 und M10-M25 für die universelle Anwendung in Stahl und Edelstahl
RT300P CVD-Beschichtetes P25-P35-TiN Hartmetall für das Schruppen in Stahl und im unterbrochenen Schnitt
RT300+ CVD-Beschichtetes Hartmetall für die Schruppbearbeitung in Stahl, auch im unterbrochenen Schnitt
RT302 PVD-Beschichtetes P15-P30 & M25-M40 Hartmetallsorte für mittlere bis Schruppbearbeitung von nichtrostendem Stahl & Stahl (Fräsen)
RT303 PVD-Beschichtetes Feinkorn-Hartmetall für die allgem. Anwendung im Fräsen (VHM)
RT305 Unbeschichtetes ISO P20-P30 Hartmetall für die Stahlbearbeitung
RT305 PVD-Sorte M20-M30 für Edelstahl mit modernster Beschichtung
RT310 TiCN-PVD-Sorte für Stahl
RT30K Unbeschichtetes K30 Hartmetallsubstrat für die Bearbeitung von Stahl, nichtrostendem Stahl, Gusswerkstoffen und NE-Metalle
RT313 PVD-Multifunktionale P25/M25 Hartmetallsorte
RT315 PVD-Beschichtetes P15-P25 und M10-M25 für die universelle Anwendung in Stahl und Edelstahl
RT330 PVD-Beschichtetes P15-P25 und M10-M25 für die universelle Anwendung in Stahl und Edelstahl
RT350M CVD-Beschichtetes M20-M35 Hartmetall für die Fräsbearbeitung in Edelstahl
RT350P CVD-Beschichtetes P20-P35 Hartmetall für die Fräsbearbeitung in Stahl
RT400 CVD-Beschichtetes P30-P40-TiN Hartmetall für die Fräsbearbeitung in Stahl
RT400+ CVD-Beschichtetes P30-P40 Hartmetall für die Fräsbearbeitung in Stahl
RT400P PVD-Beschichtete P40-Hartmetallsorte für die grobe Stahlbearbeitung
RT402 PVD-Beschichtete P20-M30/K20-K30 Hartmetallsorte für die Bearbeitung von Stahl & Gusswerkstoffen. Besonders geeignet für Gewindeformerwerkzeuge
RT405 PVD-TiAlN-Beschichtete High-Performance-Sorte für VHM-Fräser
RT520 Moderne Beschichtungs-Technologie für eine hohe Temperaturbeständigkeit
RT555 PVD beschichtetes Hartmetallsubstrat für die Hartbearbeitung von stahl (bis HRC 55-68). Höchste Verschleißfestigkeit und Zähigkeit.
RT715K CVD-Beschichtetes K10-K20 Hartmetall für die Gussbearbeitung
RTC20T TiN-Beschichtetes CBN für den vollen bis leicht unterbrochenen Schnitt in gehärteten Stählen
RTD10 Polykristalliner Diamant für die High-Speed Bearbeitung von Aluminium bis 12% Si, NE-Metalle und Kunststoff



Wir versenden mit UPS

Maschinenstillstand kostet Geld



Wir wissen es. Deswegen versenden wir mit UPS.

Preise verstehen sich Netto zzgl. MwSt. Irrtümer und Druckfehler vorbehalten



Rheinstr. 61
45478 Mülheim Ruhr

Tel.: +49 (0)208 - 848 67 82
Fax: +49 (0)208 - 848 67 84

www.rinaldi-tools.com
info@rinaldi-tools.com